

# SPEAKER STAND

# ST-16A

## 1. SAFETY PRECAUTIONS

- Before installation or use, be sure to carefully read all the instructions in this section for correct and safe operation.
- Be sure to follow all the precautionary instructions in this section, which contain important warnings and/or cautions regarding safety.
- After reading, keep this manual handy for future reference.

### **WARNING**

Indicates a potentially hazardous situation which, if mishandled, could result in death or serious personal injury.

- Do not mount the speaker of 7 kg or more. The stand or its internal pipe may fall down or drop, resulting in personal injury. Even though the speaker weight is below 7 kg, do not use that speaker if the stand is made unstable.
  - Do not extend the internal pipe beyond the **MAXIMUM** point marked in red. Doing so may make the stand unstable, and cause the stand or its internal pipe to fall down or drop, resulting in personal injury.
  - Avoid installing the stand in the following locations. Otherwise, the mounted speaker may drop or the stand may fall, resulting in personal injury.
    - Doorway or other high traffic area where people may trip on the stand.
    - Locations where the unit is exposed to a strong wind.
    - Unstable locations, such as on a rickety table or a slanted surface.
- Important:** Even in locations other than the above, if the unit may fall down, take appropriate fall preventive measures.
- When adjusting the stand height with the speaker mounted, hold the speaker firmly. Doing otherwise may cause the stand to fall, resulting in personal injury and/or property damage.
  - Fully expand the legs. If the legs are not fully expanded, the stand may fall down, resulting in personal injury.

## 2. HOW TO USE

### Attach the bracket to the speaker

**Step 1.** Attach the bracket to the speaker as shown below.

Attachment to the horn speaker

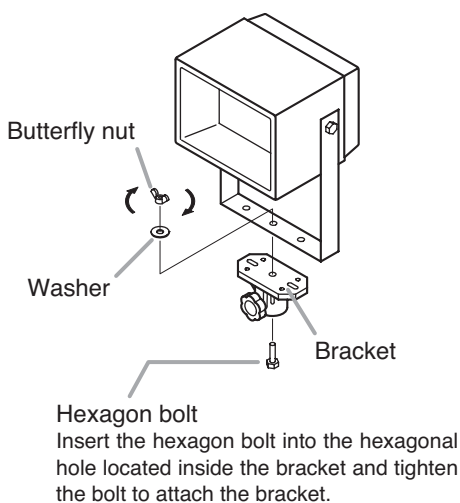

Attachment to the megaphone

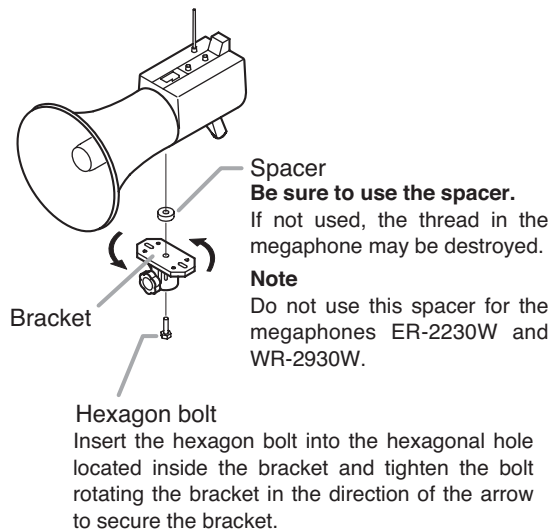

Attachment to the FGM speaker

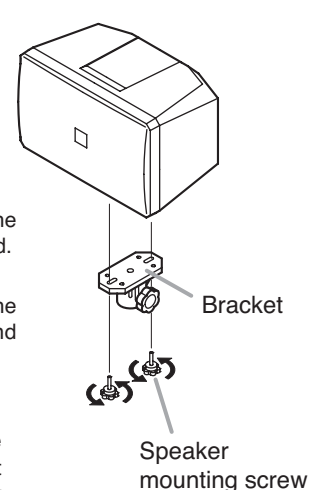

## Put up the stand

**Step 2.** Loosen the leg locking knob to fully expand the legs. Lowering the slide leg adjustment till it hits the stopper in the center of the external pipe permits maximum leg expansion.

**Step 3.** Tighten the leg locking knob to secure the legs.

**Step 4.** Loosen the internal pipe locking knob to raise the internal pipe to the desired height.

**Step 5.** Tighten the internal pipe locking knob to secure the pipe.

## Mount the speaker on the stand

**Step 6.** Insert the bracket onto the top of the internal pipe, and mount the speaker on the stand.

**Step 7.** After determining the orientation of the speaker, secure the speaker by tightening the bracket fixing knob.

**Note:** After installation completion, ensure again that every knob is tightened.

## Put away the stand after use

**Step 8.** After use, reverse the procedures 1 – 7 above to detach the speaker and fold the stand.

**Note:** Be sure to fold the stand after detaching the speaker from the stand.



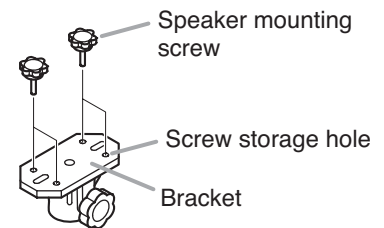

### [Storing mounting screws]

Speaker mounting screws for installing the FGM speakers can be stored by mounting them into the storage holes provided in the bracket. Use these holes to prevent the loss of screws while putting away the equipment.



## 3. PART NAMES

### Accessory

-  Speaker mounting screw (M5 x 20) x 2
-  Hexagon bolt (M8 x 20) x 1
-  Washer x 1
-  Spacer x 1
-  Butterfly nut x 1

### Stand (when folded)

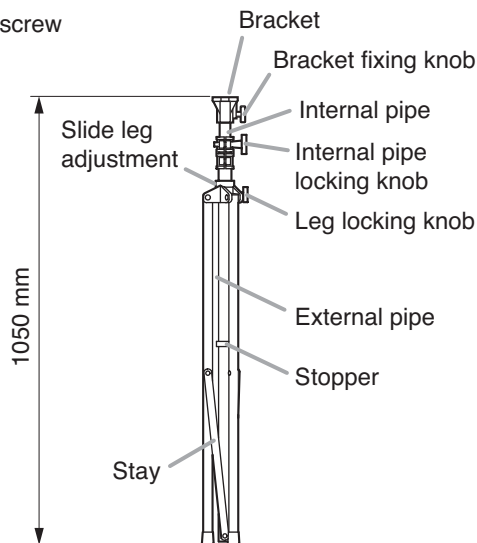

Weight: 1.7 kg (bracket included)

### Stand (when in use)

