

# INTEGRATED VOICE EVACUATION SYSTEM VX-3000 SERIES

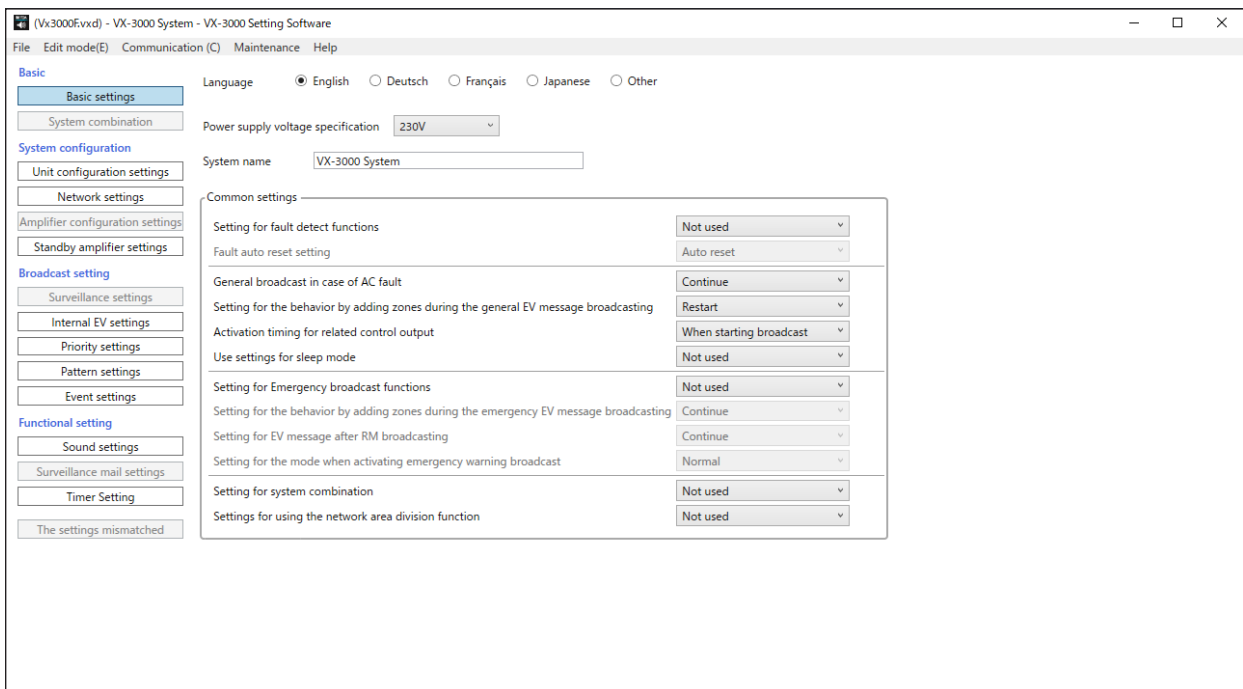

**Note**

This manual explains the connections, settings, operations, and restrictions for the System combination function.

The System combination function allows the number of the VX-3000F units to be increased to 41 or more.

When using the System combination function, be sure to see this manual in addition to the Installation instructions, Setting software instructions, and Operation manual of the VX-3000 series.

**Tip**

In this manual, the VX-3000 Frames (VX-3004F, VX-3008F, and VX-3016F) are collectively referred to as "VX-3000F."

Thank you for purchasing TOA's Integrated Voice Evacuation System.  
Please carefully follow the instructions in this manual to ensure long, trouble-free use of your equipment.

# TABLE OF CONTENTS

<b>1. WHAT IS THE SYSTEM COMBINATION FUNCTION?</b> .....	3
1.1. General Description of the System Combination Function .....	3
1.2. Cooperative Operations Using The System Combination Function .....	4
1.3. Major Restrictions on Use of The System Combination Function .....	5
<b>2. NOTES ON INSTALLATION</b> .....	7
<b>3. SETTINGS AND NOTES</b> .....	8
3.1. Basic Settings .....	8
3.2. System Combination .....	9
3.3. Network Settings .....	13
3.4. Priority Settings .....	13
3.5. Pattern Settings .....	14
3.6. Setting File Configuration .....	17
3.7. Maintenance Screen .....	18
<b>4. DIFFERENCE IN THE INDICATOR DISPLAY CONTENTS ON THE REMOTE MICROPHONE</b> .....	19
4.1. Talk Key-Related Broadcast Status Indicator on the Remote Microphone .....	19
4.2. Indicator State at the Time of General/BGM Broadcast .....	20
4.3. Broadcast Status Indicator on the Remote Microphone during Restoration Broadcast .....	21
4.4. Broadcast Status Indicator on the Remote Microphone during the Emergency Warning Broadcast .....	23
<b>5. DIFFERENCE IN THE INDICATOR DISPLAY CONTENTS ON THE CONTROL PANEL</b> .....	24
5.1. Indicator State at the Time of General/BGM Broadcast .....	24
5.2. Indicator State at the Time of Zone Selection during Restoration Broadcast .....	25
5.3. Status Indicator during the Emergency Warning Broadcast .....	26

# 1. WHAT IS THE SYSTEM COMBINATION FUNCTION?

## 1.1. General Description of the System Combination Function

The VX-3000 system allows up to 40 VX-3000F units to be used per system, providing up to 640 zones, up to 1440 control inputs, and up to 1360 control outputs.

When more number of zones, control inputs, and control outputs are required, up to 4 VX-3000 systems can be used as an integrated system by combining other VX-3000 systems together.

This function is referred to as the System combination function.

By combining 4 systems together, the number of zones, contact inputs, and contact outputs can be increased up to 2560, up to 5760, and up to 5440 in total, respectively.

The System combination function allows up to 4 VX-3000 systems to work together like a single system, while there are various restrictions on the connections, settings, and operations.

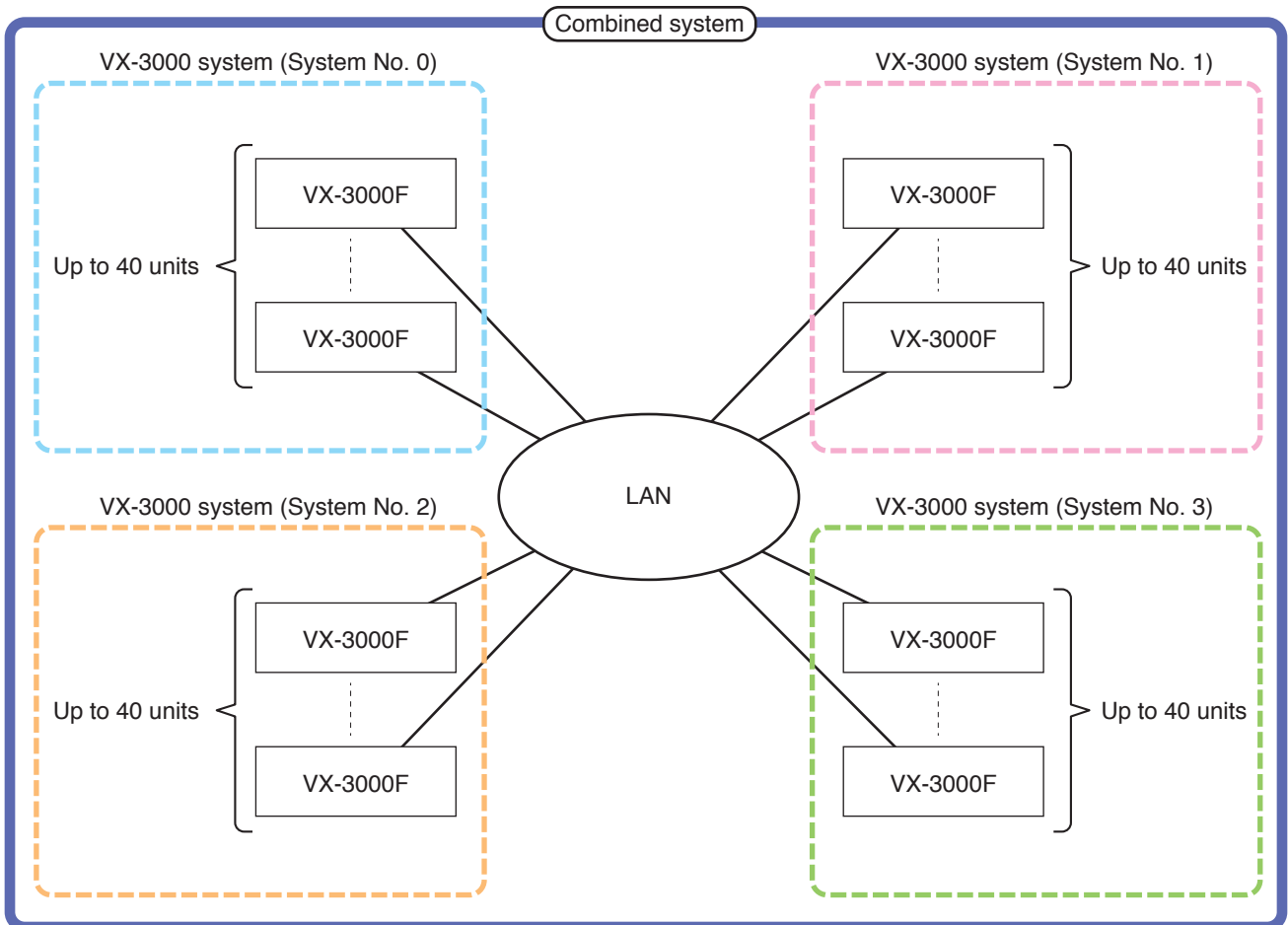

## **1.2. Cooperative Operations Using The System Combination Function**

The System combination function makes the following cooperative operations available among up to 4 VX-3000 systems.

### **1.2.1. Intersystem broadcasting**

It is possible to include the output zone patterns of the other VX-3000 system into those of own system, enabling the sound sources from the remote microphones, the VX-3000F's audio inputs, the VX-3000PM's audio inputs, and the EV sound sources to be broadcast to the output zones of the other VX-3000 system.

### **1.2.2. Controlling the control output pattern information among the systems**

It is possible to interlock the control output pattern of the other VX-3000 system with the Event.

### **1.2.3. Sharing the failure information among the systems**

It is possible to include the failure pattern of the other VX-3000 system into that of own system. It is also possible to acknowledge failure status of the other VX-3000 system through the remote microphone key operation.

### **1.2.4. Interlock of the emergency broadcast**

It is possible to include the output zone patterns of the other VX-3000 system into those of own system, permitting the emergency mode to be interlocked when the emergency broadcast is made to the output zones of the other VX-3000 system.

All the linked VX-3000 systems are interlocked to perform the phase shift and reset of the emergency mode at the emergency broadcast and emergency reset.

### **1.2.5. Confirming the broadcast status among the systems**

The broadcast status can be monitored among the VX-3000 systems.

The broadcast status of the other VX-3000 system can be confirmed by checking the broadcast status indicators on the remote microphone.

## 1.3. Major Restrictions on Use of The System Combination Function

### 1.3.1. LAN terminal connection

When the System combination function is used, the VX-3000F's, VX-3000PM's, and VX-3000CT's LAN terminal in a system cannot be connected to that in the different VX-3000 system.

### 1.3.2. VX-3000DS connection

When the System combination function is used, the VX-3000F's DS-LINK terminal in a system cannot be connected to that in the different VX-3000 system.

### 1.3.3. Making the settings using the Setting software on each system's setting screen

- Perform settings on the VX-3000 Setting software by switching the screen of each system. Settings for 2 or more systems cannot be simultaneously performed.
- When the unit configuration is received, the multiple system information can be acquired and listed on the screen. But you need to select the VX-3000F to be set for each system individually.

### 1.3.4. Broadcast sound sources and output zone settings

- Sound sources of the other VX-3000 system cannot be set as the broadcast sound sources of own system.
- In the base pattern setting, the output zone of the other VX-3000 system cannot be set as the broadcast destination of own system.
- When making broadcast to the zones of the other VX-3000 system, individual zone cannot be set as the broadcast destinations of own system. Only the output zone pattern can be set.
- The Mixing setting of the broadcast sound sources does not apply when making broadcasts to the other VX-3000 system. All broadcast sound sources are mixed and output regardless of the mixing setting.
- Broadcast using a unicast audio stream by the VX-3000PM cannot be made to the other VX-3000 system.

### 1.3.5. Making operation and display on the maintenance screen of the setting software by the unit of a system

- The system status or operation history is displayed on the maintenance screen of the VX-3000 Setting software by the unit of a system.
- Operation such as initial value adjustment, time adjustment, and ANC measurement on the maintenance screen of the VX-3000 Setting software is made by the unit of a system.

### 1.3.6. Communications among the systems

When the system combination function is used, the VX-3000F (ID: 0) units of each VX-3000 system communicate among themselves, realizing the function in the combined system.

Therefore, if the communications among the VX-3000F (ID: 0) units are disconnected, the combined system function does not operate even when the VX-3000F units with the IDs other than "0" operate correctly.

### 1.3.7. Priority control of broadcast

- Broadcast priority level is based on the priority level set in the VX-3000 system having the broadcast sound source.
- When broadcasts with the same priority are simultaneously started, their priority type "LIFO" or "FIFO" depends on the VX-3000 system setting at the broadcast destination.
- All the broadcast requests among the systems will be discarded if the link among the VX-3000 systems is disconnected. When the link is restored, the broadcast request arises once again. Accordingly, the broadcast order may reverse, possibly broadcasting other sound source than originally intended.

#### Tip

To facilitate the operation, it is recommended to match the priority control setting among VX-3000 systems.

### **1.3.8. Functions related to the emergency broadcast**

Use of the emergency broadcast function depends on the setting in each VX-3000 system. However, even when the emergency broadcast function is set to "Not used," the broadcast is placed in emergency mode if the emergency broadcast is activated from the VX-3000 system where its function is set to "Used."

#### **Tip**

To facilitate the operation, it is recommended to match the use setting of the emergency broadcast function among VX-3000 systems.

### **1.3.9. Pattern setting**

- The output zone pattern, control output pattern, and failure pattern of the other VX-3000 system can be assigned to the output zone pattern, control output pattern, and failure pattern of own system, respectively. However, individual output zones, control outputs, and failure detection points cannot be set.
- When the control output pattern, failure pattern, and output zone pattern of the other VX-3000 system are set, those patterns cannot be interlocked to operate if they include another VX-3000 system's pattern.

### **1.3.10. Power supply**

Only the VX-3000DS connected to the VX-3000F within the same VX-3000 system can be used as the power source.

### **1.3.11. Standby amplifier**

Only the VX-3000F units within the same VX-3000 system can share the standby amplifier.

### **1.3.12. Indicators on the remote microphone**

When the system combination function is used, the broadcast status indicator of the talk key and the status indicators of the function keys on the remote microphone operate in a different manner from the original.

### **1.3.13. Audio network port (UDP) setting**

When setting the values from start to end for the audio network port, the same value cannot be applied to a different VX-3000 system.

### **1.3.14. Modbus control**

Control using the Modbus can be executed only by the unit of a system.

### **1.3.15. Volume control by the VX-3000CT**

The volume adjustment function by way of the VX-3000CT's volume control knobs does not apply to the volume control of the other VX-3000 system's zone pattern.

## 2. NOTES ON INSTALLATION

When the System combination function is used, the VX-3000F's, VX-3000PM's, and VX-3000CT's LAN terminal in a system cannot be connected to that in the different VX-3000 system.

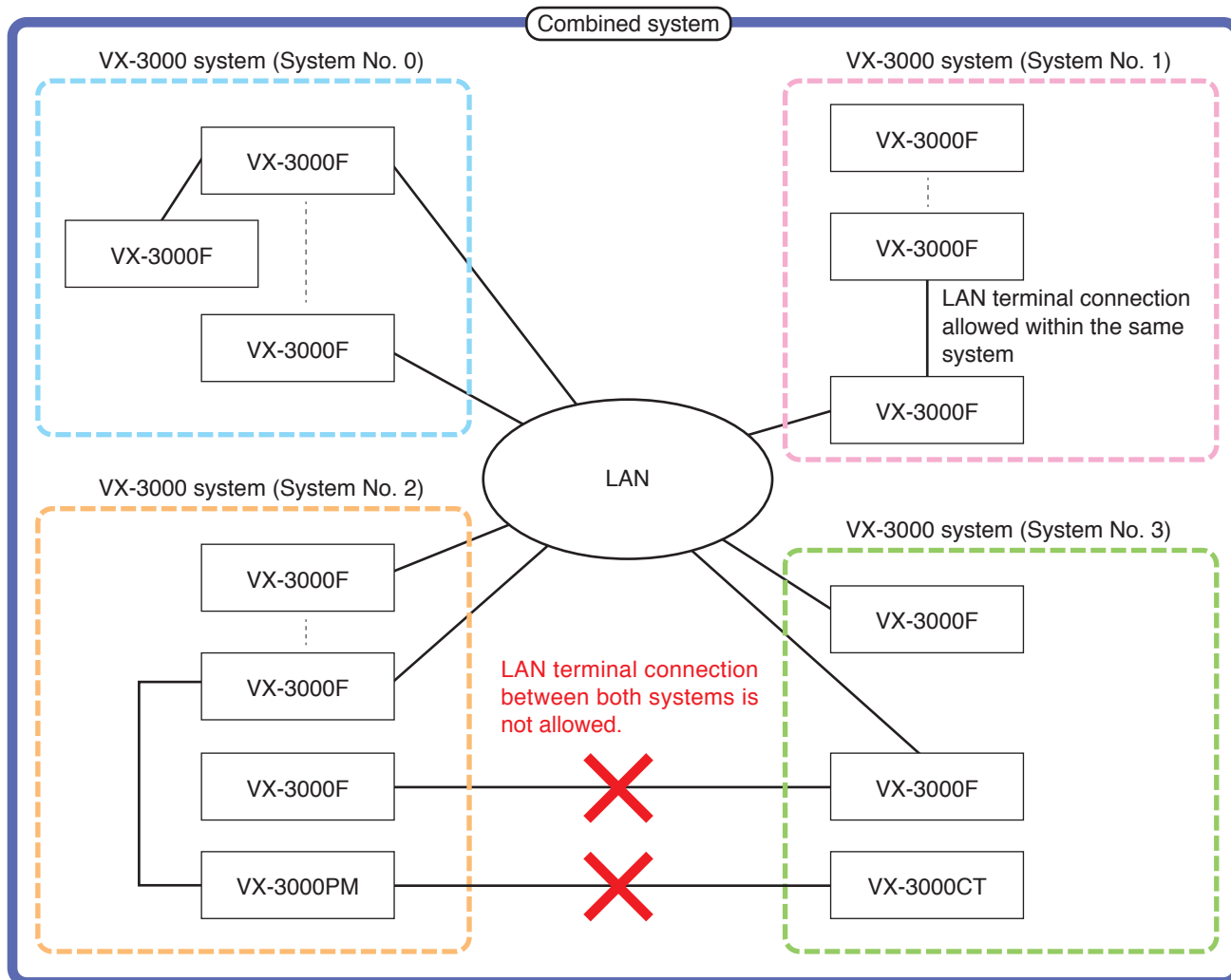

Direct connection without switching hub as shown below is not allowed as well.

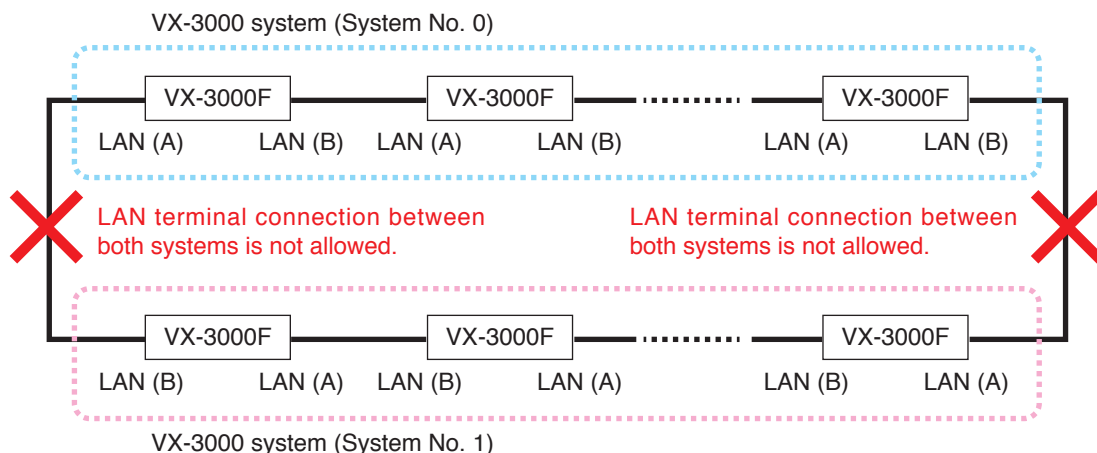

### 3. SETTINGS AND NOTES

When the system combination function is used, the settings on the VX-3000 Setting software are different in some parts from those for a single system.

This manual describes focusing on such different parts.

Please see this manual together with the VX-3000 Setting Software Instructions.

#### 3.1. Basic Settings

**Step:** Set "Setting for system combination" to "Used" on the Basic setting screen.

The System combination button becomes active.

The file name and system name of the single system corresponding to the setting target appear in the title bar on the setting screen.

System combination button

File name of the setting data

System name (name of the system being edited)

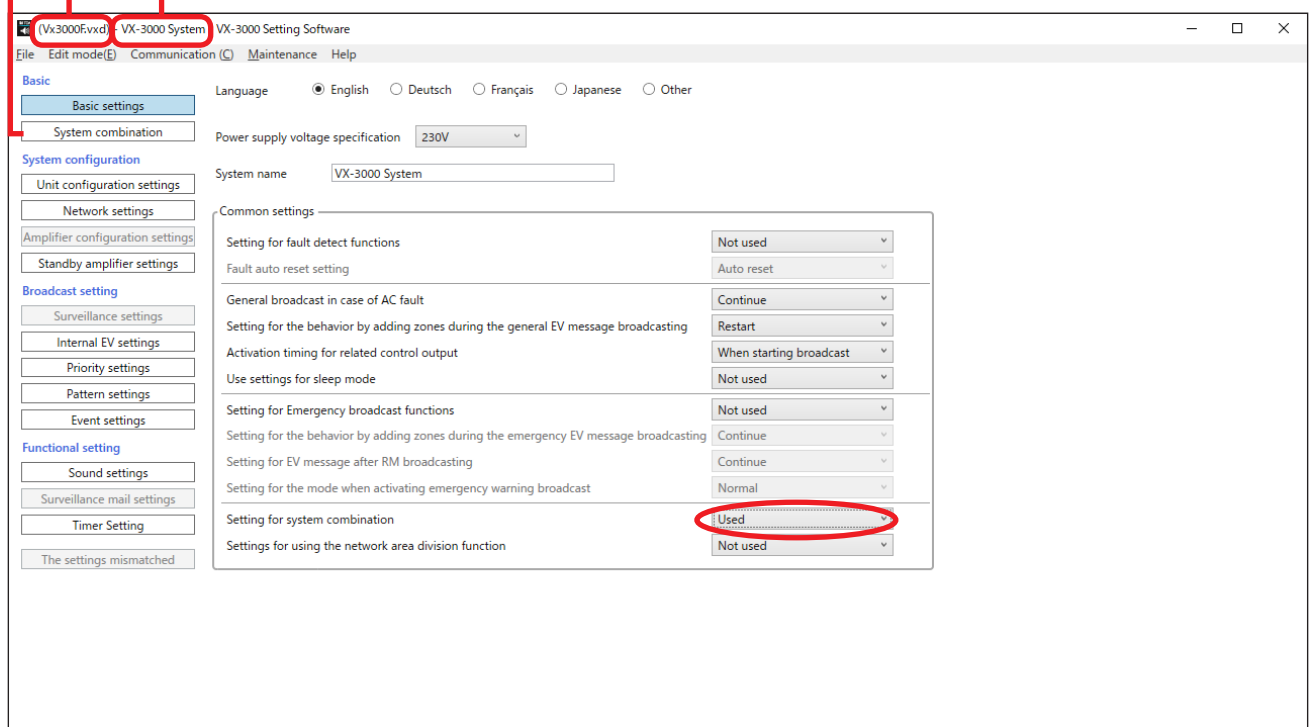

#### Tip

To facilitate the operation, it is recommended to match all the common settings among VX-3000 systems.



## 3.2. System Combination

Clicking the System combination button shows the screen below.

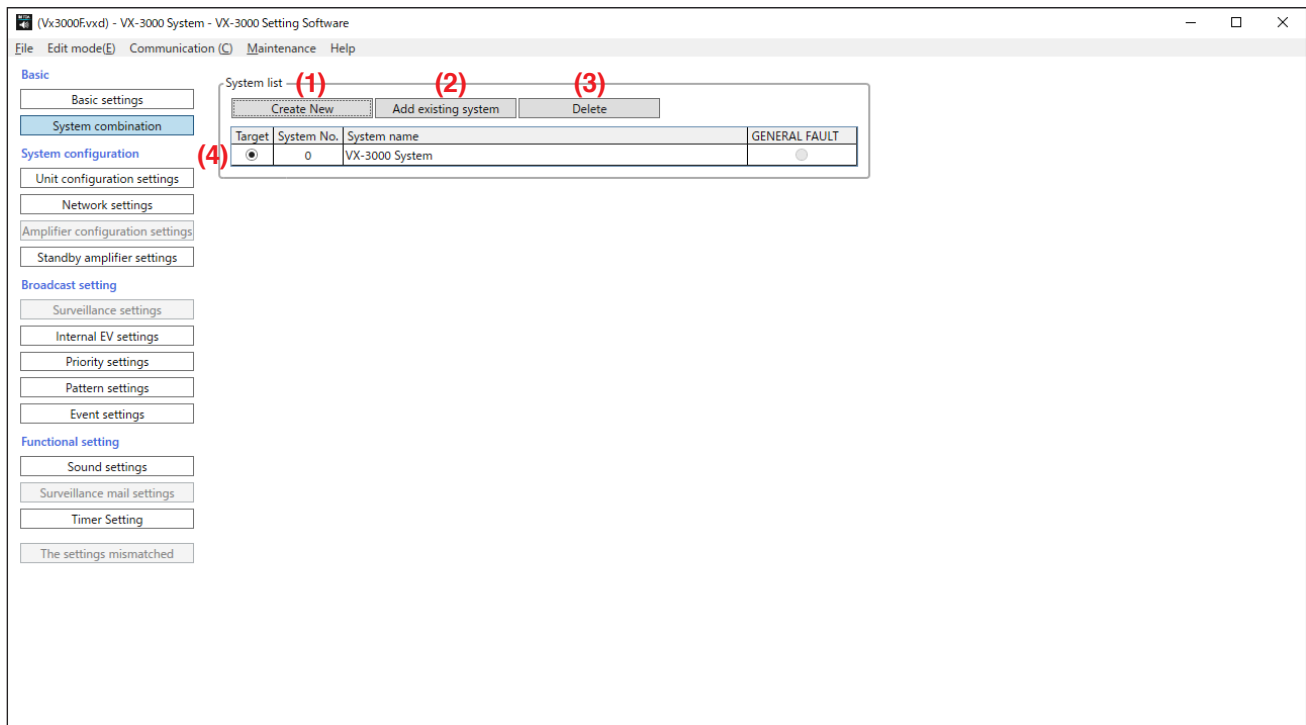

### (1) Create New Button

Newly creates and registers the system to be combined.

### (2) Add existing system Button

Reads the saved setting file (extension: vxd) of the existing system and additionally registers it.

### (3) Delete Button

Excludes the designated system from the target systems to be combined.

### (4) Target System List

#### • Target Selection Radio Button

Selects the system to be set.

#### • System No.

Displays the system number, which cannot be changed.

#### • System name

Displays the system name set on the Basic settings screen. It cannot be changed on this screen.

#### • GENERAL FAULT Selection Radio Button

Designates the VX-3000F which notifies the failure of the combined entire VX-3000 system when the failure detection function is used.

Setting the "Setting for fault detect functions" to "Used" on the Basic settings screen makes the GENERAL FAULT selection radio button for the corresponding system active.

Only one GENERAL FAULT selection radio button can be selected throughout the combined entire VX-3000 system.

If a failure occurs somewhere in the combined entire VX-3000 system, the General fault indicator on the VX-3000F (ID: 0) belonging to the VX-3000 system selected here indicates the failure status.

### 3.2.1. Newly creating the system to be combined

Up to 4 systems to be combined can be registered by newly creating the systems or by adding the systems from the existing ones.

When creating a new system to be combined, follow the procedures bellow to register it.

**Step 1.** Click the Create New button on the System combination screen.

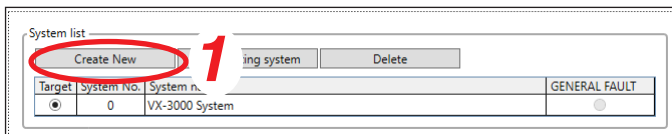

A new creation screen appears.

**Step 2.** Enter the number of the VX-3000F (with amplifier) units.

Enter a number from "0" to "40."

Shown below are the initial settings.

VX-3004F: 1

VX-3008F: 0

VX-3016F: 0

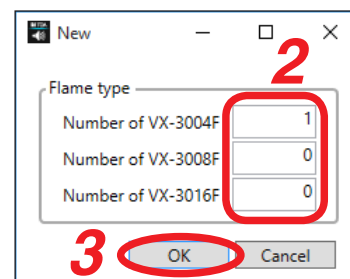

#### Notes

- The total number of the units must be set in the range of 1 to 40.
- Up to 40 VX-3000F units including the extension units can be used in a system.

**Step 3.** Click the OK button.

A newly created system is added to the Target system list, and the edit target on the setting screen moves to this system.

The content set in **Step 2** is reflected to the Unit configuration settings screen.

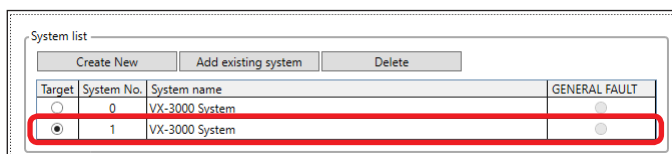

**Step 4.** Click the button from the top (Basic settings) of the menu items to the bottom in turn and perform necessary settings on each corresponding screen.

### 3.2.2. Adding the system to be combined from the existing ones

Up to 4 systems to be combined can be registered by newly creating the systems or by adding the systems from the existing ones.

When adding the system from the existing ones, follow the procedures bellow to register it.

**Step 1.** Click the "Add existing system" button on the System combination screen.

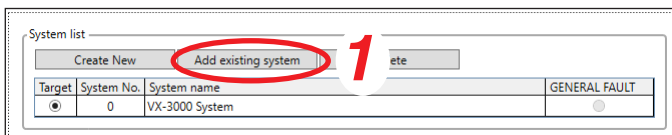

The "Open" dialog appears.

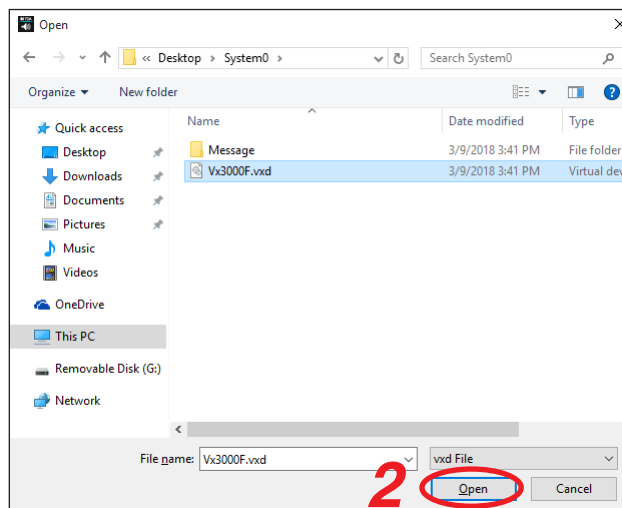

**Step 2.** Select the setting file (extension: vxd) from the storage folder of the existing system, then click the "Open" button.

The existing system is added to the Target system list and the edit target on the setting screen moves to this system.

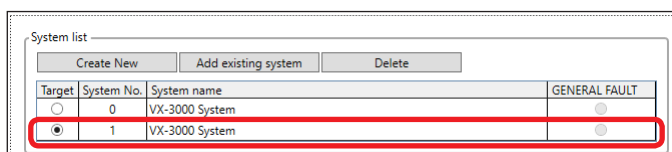

### 3.2.3. Deleting the combination target system

Exclude the system registered as the combination target one from the target system list.

**Step 1.** Click the Delete button on the System combination screen.

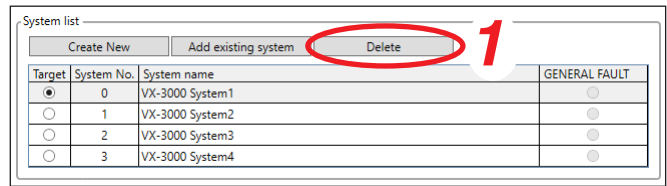

The "Unbinding the combined system" screen appears.

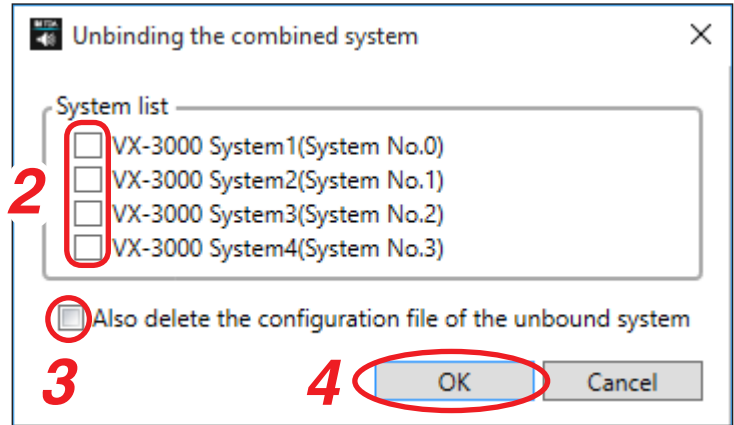

**Step 2.** Check the checkbox for the system to be deleted.

**Note**

Clicking all the checkboxes returns all settings including the system combination function to the default settings, placing the setting screen in the new creation status of the system that does not use the system combination function.

**Step 3.** Check the checkbox for the "Also delete the configuration file of the unbound system" as needed.

**Step 4.** Click the OK button.

The selected system is deleted from the target system list.

### 3.3. Network Settings

Shown below is the Network settings screen when the system combination function is used.

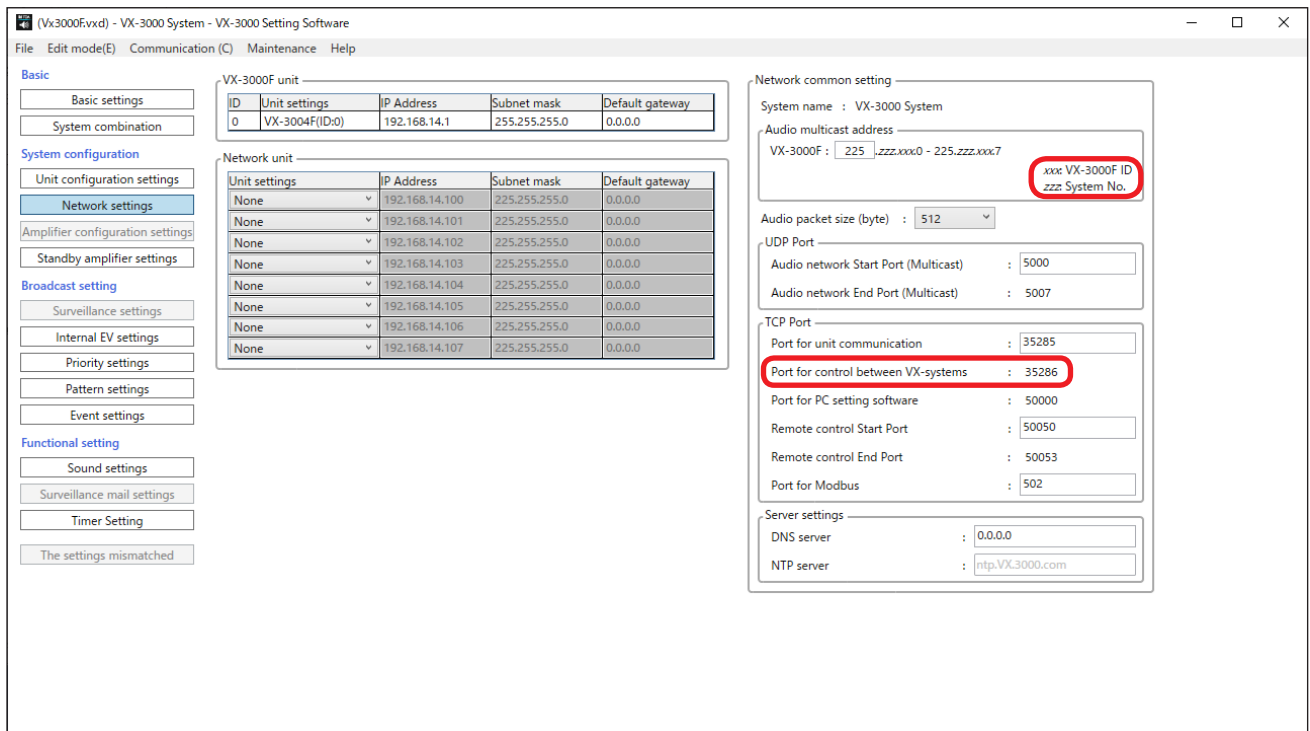

Only the parts enclosed with red frames are added in the setting screen. These parts are displayed only and cannot be changed.

### 3.4. Priority Settings

The Priority settings screen remains unchanged when the system combination function is used. To facilitate the operation, it is recommended to match the setting of the same priority (selection of "Priority first" or "Priority last") for each VX-3000 system.

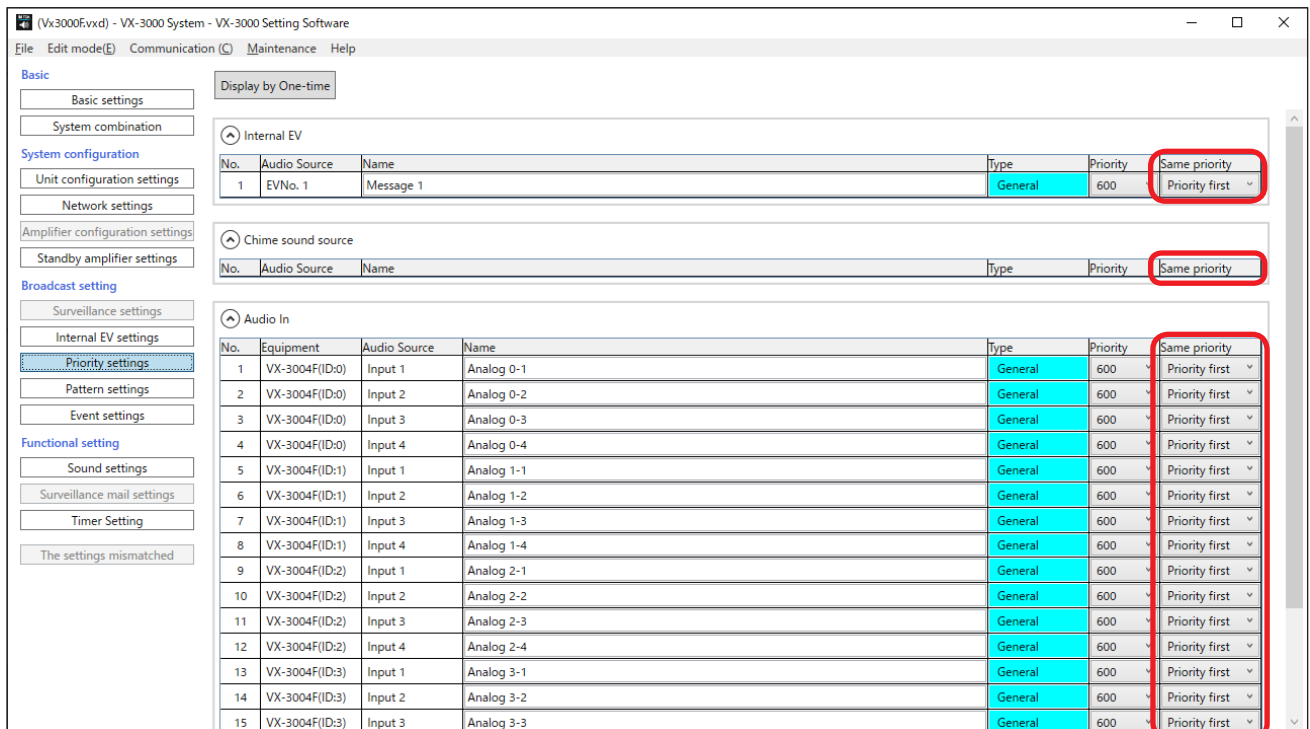

## 3.5. Pattern Settings

### 3.5.1. Output zone pattern setting

Shown below is the Output zone pattern setting screen when the system combination function is used.

The screenshot shows the 'VX-3000 Setting Software' interface. The 'Zone' tab is active, displaying a table of zone patterns for four VX-3004F systems. The 'Zone pattern of the combined system' table at the bottom is highlighted with a red frame.

System No.	System name	Zone pattern
1	VX-3000 System2	0001 : Zone pattern 1
2	VX-3000 System3	None
3	VX-3000 System4	None

The setting item enclosed with a red frame is added.

**Step 1.** Set as many zone patterns containing only the zones within the system as needed to each VX-3000 system.

**Note**

Only the output zone patterns can be set as the broadcast zones of other VX-3000 systems.

When you want to assign only a single zone as the broadcast zone of the other VX-3000 system, set the output zone pattern that contains only a single zone.

**Step 2.** Set the output zone pattern containing the zone patterns of other VX-3000 systems.

Select the output zone pattern of the other VX-3000 system from the pull-down menu of the "Zone pattern of the combined system."

**Notes**

- You can select only one output zone pattern of the other VX-3000 system per system.
- Even if the output zone pattern of the other system includes that of the different VX-3000 system, broadcasts cannot be made to such different system's zones.

### 3.5.2. Base pattern setting

**Note**

The base pattern cannot be broadcast to the output zones of other VX-3000 systems.

The Base pattern setting screen remains unchanged when the system combination function is used.

### 3.5.3. Control output pattern setting

Shown below is the Control output pattern setting screen when the system combination function is used.

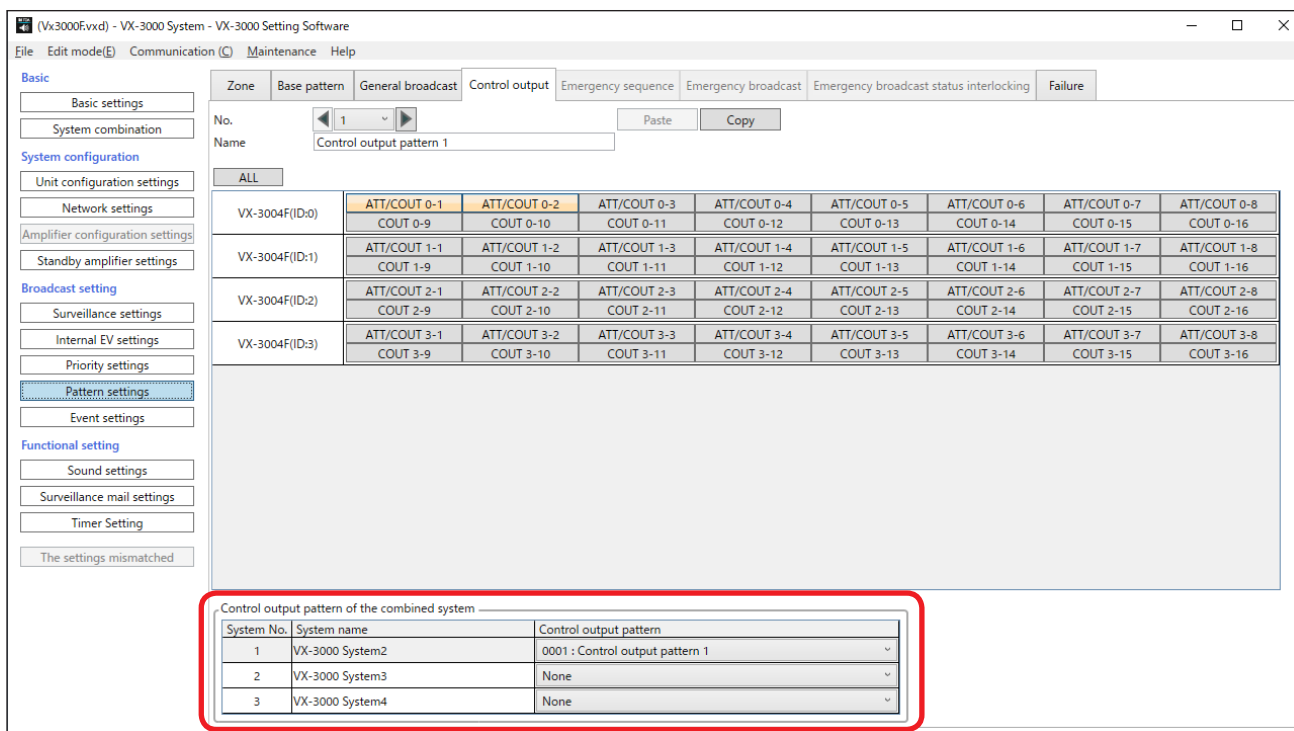

The setting item enclosed with a red frame is added.

**Step 1.** Set as many control output patterns containing only the control outputs within the system as needed to each VX-3000 system.

**Note**

Only the control output patterns can be set as the control outputs of other VX-3000 systems. When you want to assign only a single control output to the control output pattern of the other VX-3000 system, set the control output pattern that contains only a single control output.

**Step 2.** Set the control output pattern containing the control output patterns of other VX-3000 systems. Select the control output pattern of the other VX-3000 system from the pull-down menu of the "Control output pattern of the combined system."

**Notes**

- You can select only one control output pattern of the other VX-3000 system per system.
- Even if the control output pattern of the other system includes that of the different VX-3000 system, the control outputs of such different system will not work.

### 3.5.4. Failure pattern setting

In the case of the system that uses the failure detection function, shown below is the failure pattern setting screen when the System combination function is used.

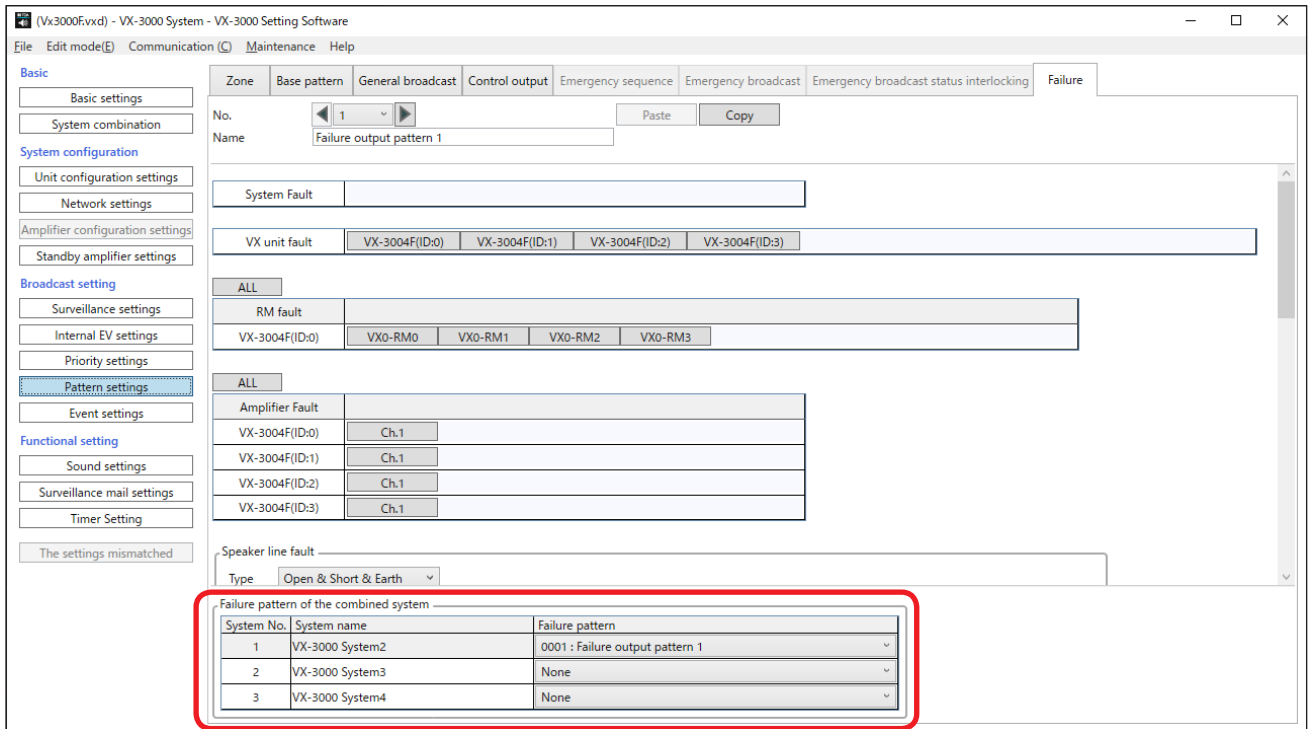

The setting item enclosed with a red frame is added.

**Step 1.** Set as many failure patterns containing only the failure detection points within the system as needed to each VX-3000 system.

**Note**

Only the failure patterns can be set as the failure detection points of other VX-3000 systems. When you want to assign only a single failure detection point to the failure pattern of the other VX-3000 system, set the failure pattern that contains only a single failure detection point.

**Step 2.** Set the failure pattern containing the failure patterns of other VX-3000 systems. Select the failure pattern of the other VX-3000 system from the pull-down menu of the "Failure pattern of the combined system."

**Notes**

- You can select only one failure pattern of the other VX-3000 system per system.
- Even if the failure pattern of the other system includes that of the different VX-3000 system, the failure detection points of such different system are not detected.



## 3.6. Setting File Configuration

### 3.6.1. File configuration

When the system combination function is used, saving the settings allows the VX-3000 system combination file (extension: vxp) to be created in addition to the setting file (extension: vxd, vxt) of each VX-3000 system. Shown below is an example of file configuration.

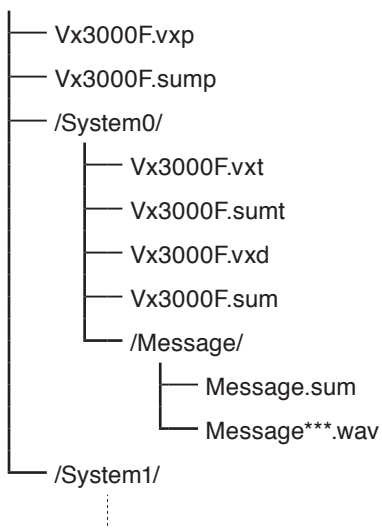

### 3.6.2. Setting file read and edit

- To edit the VX-3000 system that uses the system combination function, open the VX-3000 system combination file (extension: vxp) by selecting [File] → [Open] from the menu on the VX-3000 Setting software.
- Select the target system on the System combination screen, then edit its setting by each system. If you attempt to switch the target system after edit completion, a dialog at right appears, then click the "Yes" button to save the setting file (extension: vxd) of the edited VX-3000 system.
- The VX-3000 system combination file (extension: vxp) can be saved by selecting [File] → [Save] or [Save as] from the menu on the VX-3000 Setting software.

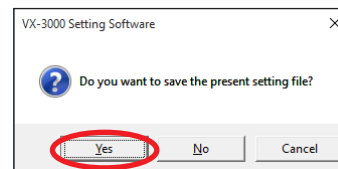

### 3.6.3. Setting file upload and download

- Selecting [Communication] → [Setting data & Audio source upload (PC->VX)] uploads the setting file to the individual connected VX-3000 systems in turn. If another system to be uploaded to exists after upload completion of one system, the dialog will appear, then click the Yes button to upload to the next system.
- If [Communication] → [Setting data & Audio source download (VX->PC)] is selected from the menu on the VX-3000 Setting software, a confirmation dialog will appear when the combined system exists, then click the Yes button. The set data of all systems are downloaded simultaneously.
- Selecting [Communication] → [Timer setting upload (PC->VX)] uploads the setting file to the individual connected VX-3000 systems in turn. If another system to be uploaded to exists after upload completion of one system, the dialog will appear, then click the Yes button to upload to the next system.

### 3.7. Maintenance Screen

Shown below is the Maintenance screen when the System combination function is used.

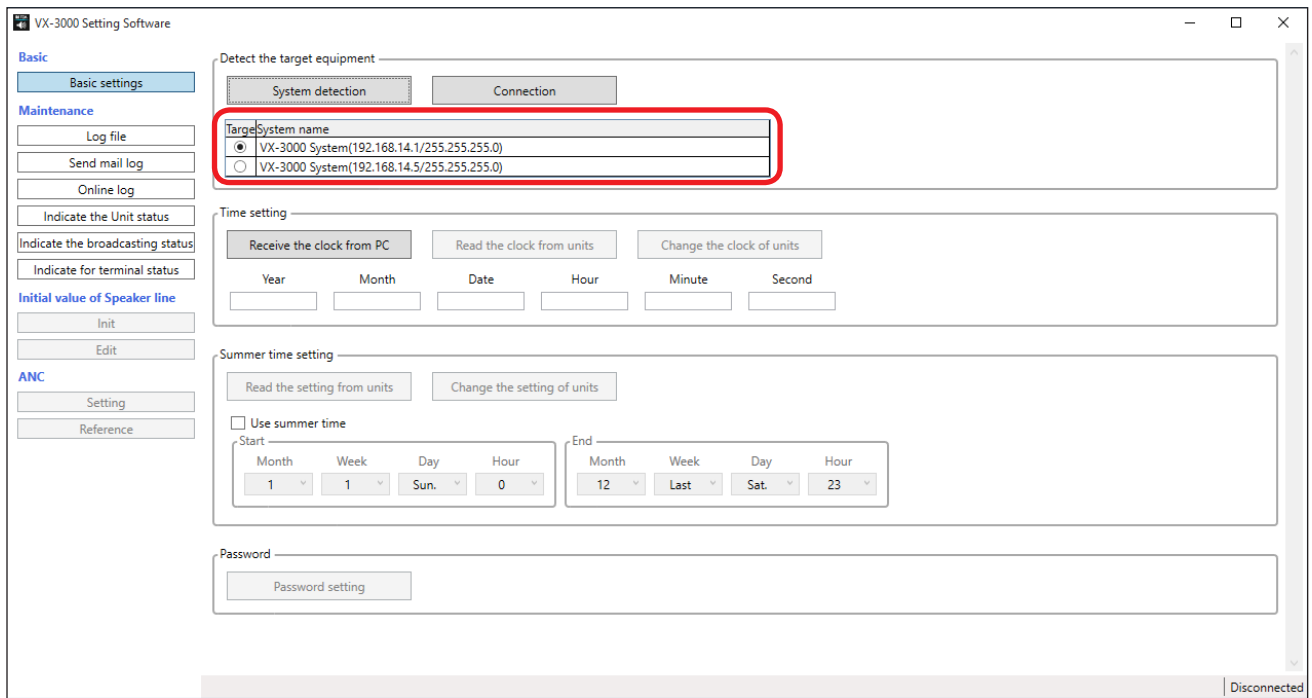

The IP address is displayed for the target system, which is different from the screen when the system combination function is not used.

#### Note

Only one system can be selected as the target system.

The individual systems constituting the combined system cannot simultaneously be targeted for maintenance on this screen.

## 4. DIFFERENCE IN THE INDICATOR DISPLAY CONTENTS ON THE REMOTE MICROPHONE

When the system combination function is used, the talk key-related broadcast status indicator and the function key-related status indicator on the remote microphone show some different contents from the original.

### 4.1. Talk Key-Related Broadcast Status Indicator on the Remote Microphone

The displayed contents of the talk key-related broadcast status indicator change as shown in the table below.



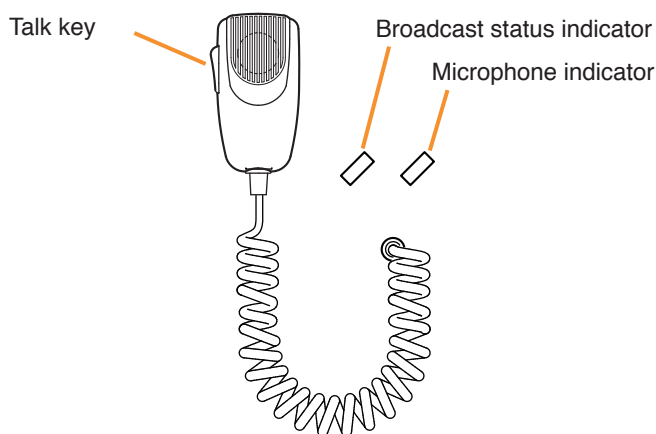

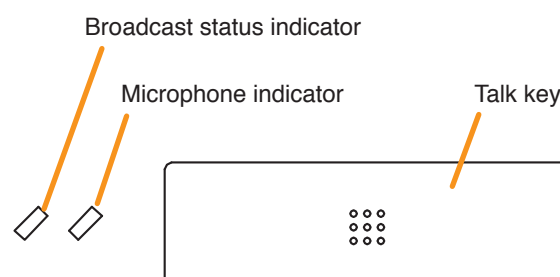

[RM-200SF]



[RM-300X]







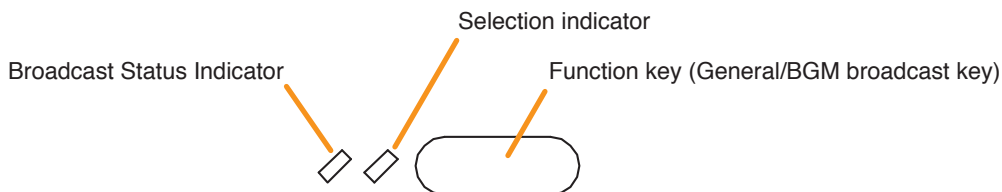

The table below shows the display contents of each indicator. (The display contents of the microphone indicator remain unchanged.)

Indicator	Status	Meaning
Microphone Indicator	Unlit 	Microphone not in use
	Lights green 	Microphone in use
	Flashes green 	Chime broadcast in progress from the primary Remote Microphone.
Broadcast Status Indicator	Unlit 	Zone not in use (microphone announcement possible)
	Flashes green 	When making broadcasts only to the zone of its own system: A broadcast is being made from another equipment (e.g. another remote microphone) to a part of or all the zones selected by this unit, or being made by this unit to a part of the zones selected by this unit.  When making broadcasts to the zones including those of other systems: A broadcast is being made to all the zones of only other systems included in the zones selected by this unit, or to all the zones of the own system and other systems. <b>Note</b> In this case, it may light yellow for a moment when a broadcast is started before flashing green.
	Lights yellow 	When making broadcasts only to the zones of the own system: A broadcast is being made from this unit to all the zones selected by this unit.  When making broadcasts to the zones including those of other systems: A broadcast is being made to all zones of only the own system included in the zones selected by this unit.

## 4.2. Indicator State at the Time of General/BGM Broadcast

When the function for the general/BGM broadcast has been assigned to the function key, the displayed contents of the broadcast status indicator change as shown in the table below. (The displayed contents of the selection indicator remain unchanged.)



Indicator	Status	Meaning
Selection Indicator	Unlit 	When the function key is not pressed
	Lights green 	When the unit is brought in general/BGM broadcast by pressing the function key
Broadcast Status Indicator	Unlit 	When a general/BGM broadcast assigned to the function key is not activated
	Lights green 	When making broadcasts only to the zone of its own system: When the audio source for a general/BGM broadcast assigned to the function key is being broadcast to the zones other than those selected by this unit.  When making broadcasts to the zones including those of other systems: When the audio source for a general/BGM broadcast assigned to the function key is being broadcast to the zones other than those of the own system selected by this unit and not to the zones of the other systems' zone patterns.
	Lights yellow 	When making broadcasts only to the zone of its own system: When the audio source for a general/BGM broadcast assigned to the function key is being broadcast to at least one of the zones selected by this unit.  When making broadcasts to the zones including those of other systems: When the audio source for a general/BGM broadcast assigned to the function key is being broadcast to at least one of the own system's zones selected by this unit and/or the zones of the other systems' zone patterns.

### Note

When making broadcasts to the zones including those of other systems, the broadcast status indicator may light green not yellow depending on the setting contents of the other systems' zone patterns even if the audio source for a general/BGM broadcast assigned to this function key is being broadcast to a part of the zones set in the zone patterns selected by this unit.

### 4.3. Broadcast Status Indicator on the Remote Microphone during Restoration Broadcast







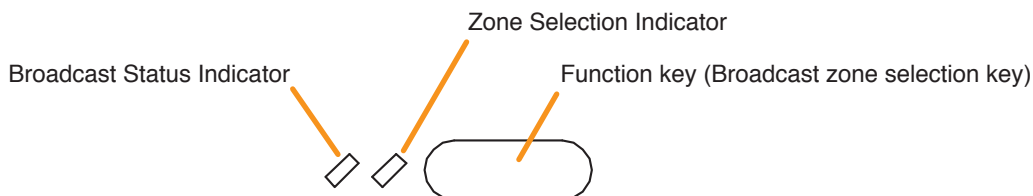

When a restoration message is being broadcast only to the other systems' zones, the broadcast status indicator for the function key to which the functions below are assigned does not light.

- Pre select (Individual)
- Pre select (Pattern)
- Emergency broadcast pattern start/stop
- Emergency reset

#### 4.3.1. Indicator state at the time of zone selection





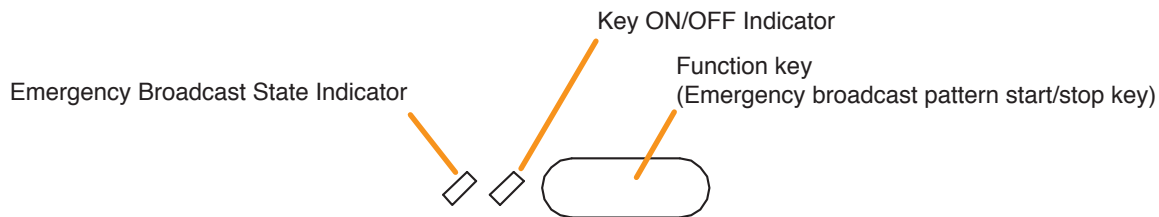

When the function for the "Pre select (Individual or Pattern)" has been assigned to the function key, the displayed contents of the broadcast status indicator change as shown in the table below. (The displayed contents of the zone selection indicator remain unchanged.)

Indicator	Status	Meaning
Zone Selection Indicator	Unlit 	No zone selected
	Lights green 	Zone selected
Broadcast Status Indicator	Unlit 	The zones assigned to this Broadcast zone selection key are not in use, BGM broadcast is being made to these zones, or a restoration message is being broadcast only to the other systems' zones.
	Flashes green 	A part of zones or the entire zone assigned to this Broadcast Zone Selection key is occupied by a broadcast from another device (secondary Remote Microphone or general EV message), or a part of zones is engaged by a broadcast from the primary Remote Microphone.
	Lights yellow 	All the zones selected by this Broadcast Zone Selection key on the primary Remote Microphone are engaged by a broadcast from the primary Remote Microphone.
	Flashes yellow 	All the zones assigned to this Broadcast Zone Selection key are engaged by a broadcast from the Secondary Emergency Remote Microphone.
	Lights red 	All the zones assigned to this Broadcast Zone Selection key are engaged by an evacuation message.
	Flashes red 	All the zones assigned to this Broadcast Zone Selection key are engaged by an alert message.
	Lights green 	All the zones assigned to this Broadcast Zone Selection key are engaged by a restoration message. <b>Note</b> When a restoration message is being broadcast only to the other systems' zones, this indicator remains unlit.

### 4.3.2. Indicator state at the time of Emergency broadcast pattern start/stop





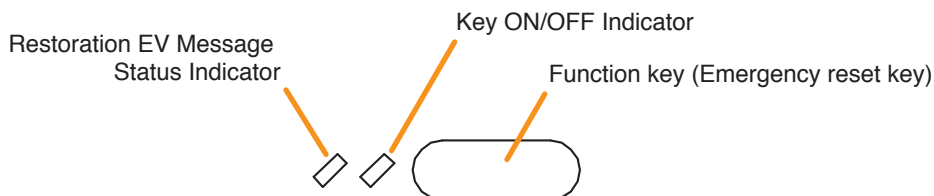

When the function for the Emergency broadcast pattern start/stop has been assigned to the function key, the displayed contents of the broadcast status indicator change as shown in the table below. (The displayed contents of the key ON/OFF indicator remain unchanged.)

Indicator	Status	Meaning
Key ON/OFF Indicator	Unlit 	When the function key is not pressed
	Lights green 	When the function key is pressed (as long as it is pressed)
Emergency Broadcast State Indicator	Unlit 	When the Emergency broadcast pattern assigned to this function key is not broadcast or a restoration message is being broadcast only to the other systems' zones.
	Lights green 	A restoration message assigned to this function key is being activated. <b>Note</b> When a restoration message is being broadcast only to the other systems' zones, this indicator remains unlit.
	Lights red 	Emergency Broadcast Pattern assigned to the function key is broadcast.

### 4.3.3. Indicator state at the time of Emergency reset







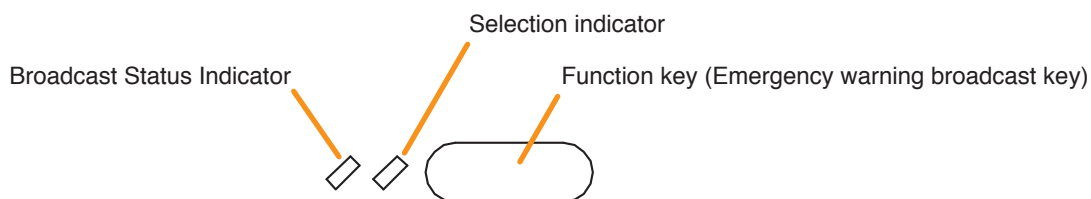

When the function for the Emergency reset has been assigned to the function key, the displayed contents of the broadcast status indicator change as shown in the table below. (The displayed contents of the key ON/OFF indicator remain unchanged.)

Indicator	Status	Meaning
Key ON/OFF Indicator	Unlit 	When the function key is not pressed
	Lights green 	When the function key is pressed (as long as it is pressed)
Restoration EV Message Status Indicator	Unlit 	A restoration message assigned to this function key is being stopped or a restoration message is being broadcast only to the other systems' zones.
	Lights green 	A restoration message assigned to this function key is being activated. <b>Note</b> When a restoration message is being broadcast only to the other systems' zones, this indicator remains unlit.

#### 4.4. Broadcast Status Indicator on the Remote Microphone during the Emergency Warning Broadcast

When the function for the Emergency warning broadcast has been assigned to the function key, the displayed contents of the broadcast status indicator change as shown in the table below. (The displayed contents of the selection indicator remain unchanged.)



Indicator	Status	Meaning
Selection Indicator	Unlit 	When the function key is not pressed
	Lights green 	When the function key is pressed
Broadcast Status Indicator	Unlit 	When the audio source for an emergency warning broadcast assigned to the function key is not broadcast to any zones
	Lights green 	When making broadcasts only to the zone of its own system: When the audio source for an emergency warning broadcast assigned to the function key is being broadcast to the zones other than those assigned to this key  When making broadcasts to the zones including those of other systems: When the audio source for an emergency warning broadcast assigned to the function key is being broadcast to the zones other than those of the own system selected by this unit and not to the zones of the other systems' zone patterns.
	Lights yellow 	When making broadcasts only to the zone of its own system: When the audio source for an emergency warning broadcast assigned to the function key is being broadcast to at least a part of the zones assigned to this key  When making broadcasts to the zones including those of other systems: When the audio source for an emergency warning broadcast assigned to the function key is being broadcast to at least one of the own system's zones selected by this unit and/or the zones of the other systems' zone patterns.

**Note**

When making broadcasts to the zones including those of other systems, the broadcast status indicator may light green, not yellow depending on the setting contents of the other systems' zone patterns even if the audio source for an emergency warning broadcast assigned to this function key is being broadcast to at least a part of the zones set in the zone patterns assigned to this key.

## 5. DIFFERENCE IN THE INDICATOR DISPLAY CONTENTS ON THE CONTROL PANEL



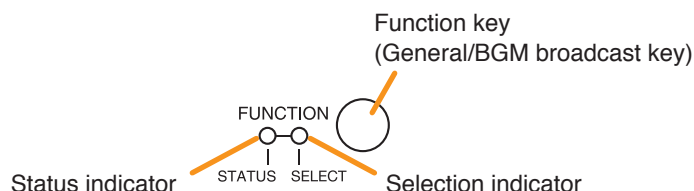

When the system combination function is used, the function key-related status indicator on the VX-3000CT Control Panel show some different contents from the original.

### 5.1. Indicator State at the Time of General/BGM Broadcast

When the function for the general/BGM broadcast has been assigned to the function key, the displayed contents of the status indicator change as shown in the table below. (The displayed contents of the selection indicator remain unchanged.)



Indicator meanings are as follows:

Indicator	Status	Meaning
Selection indicator	Unlit 	When the function key is not pressed
	Lights green 	When the unit is brought in general/BGM broadcast by pressing the function key
Status indicator	Unlit 	When a general/BGM broadcast assigned to the function key is not activated
	Lights green 	When making broadcasts only to the zone of its own system: When the audio source for a general/BGM broadcast assigned to the function key is being broadcast to the zones other than those selected by this unit.  When making broadcasts to the zones including those of other systems: When the audio source for a general/BGM broadcast assigned to the function key is being broadcast to the zones other than those of the own system selected by this unit and not to the zones of the other systems' zone patterns.
	Lights yellow 	When making broadcasts only to the zone of its own system: When the audio source for a general/BGM broadcast assigned to the function key is being broadcast to at least one of the zones selected by this unit.  When making broadcasts to the zones including those of other systems: When the audio source for a general/BGM broadcast assigned to the function key is being broadcast to at least one of the own system's zones selected by this unit and/or the zones of the other systems' zone patterns.

#### Note

When making broadcasts to the zones including those of other systems, the status indicator may light green not yellow depending on the setting contents of the other systems' zone patterns even if the audio source for a general/BGM broadcast assigned to this function key is being broadcast to a part of the zones set in the zone patterns selected by this unit.







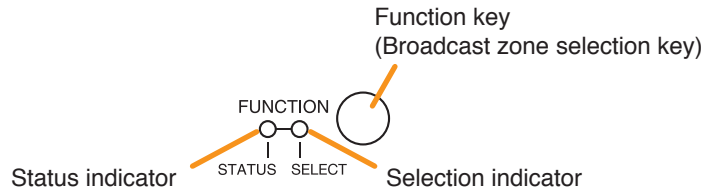



## 5.2. Indicator State at the Time of Zone Selection during Restoration Broadcast

When the function for the Pre select (Individual or Pattern) has been assigned to the function key, the displayed contents of the status indicator change as shown in the table below. (The displayed contents of the selection indicator remain unchanged.)



Indicator meanings are as follows:

Indicator	Status	Meaning
Selection indicator	Unlit 	No zone selected
	Lights green 	Zone selected
Status indicator	Unlit 	The zones assigned to this Broadcast zone selection key are not in use, BGM broadcast is being made to these zones, or a restoration message is being broadcast only to the other systems' zones.
	Flashes green 	A part of zones or the entire zone assigned to this Broadcast Zone Selection key is occupied by a broadcast from another device (Remote Microphone or general EV message)
	Flashes yellow 	All the zones assigned to this Broadcast Zone Selection key are engaged by a broadcast from the Secondary Emergency Remote Microphone.
	Lights red 	All the zones assigned to this Broadcast Zone Selection key are engaged by an evacuation message.
	Flashes red 	All the zones assigned to this Broadcast Zone Selection key are engaged by an alert message.
	Lights green 	All the zones assigned to this Broadcast Zone Selection key are engaged by a restoration message. <b>Note</b> When a restoration message is being broadcast only to the other systems' zones, this indicator remains unlit.

### 5.3. Status Indicator during the Emergency Warning Broadcast

When the function for the Emergency warning broadcast has been assigned to the function key, the displayed contents of the status indicator change as shown in the table below. (The displayed contents of the selection indicator remain unchanged.)

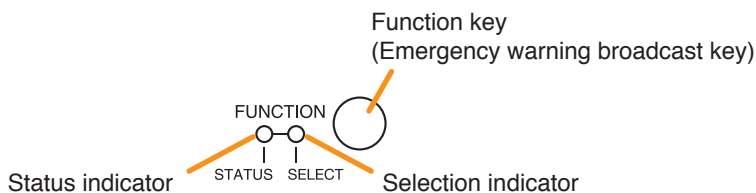

Indicator meanings are as follows:

Indicator	Status	Meaning
Selection indicator	Unlit	When the function key is not pressed
	Lights green	When the function key is pressed
Status indicator	Unlit	When the audio source for an emergency warning broadcast assigned to the function key is not broadcast to any zones
	Lights green	When making broadcasts only to the zone of its own system: When the audio source for an emergency warning broadcast assigned to the function key is being broadcast to the zones other than those assigned to this key  When making broadcasts to the zones including those of other systems: When the audio source for an emergency warning broadcast assigned to the function key is being broadcast to the zones other than those of the own system selected by this unit and not to the zones of the other systems' zone patterns.
	Lights yellow	When making broadcasts only to the zone of its own system: When the audio source for an emergency warning broadcast assigned to the function key is being broadcast to at least a part of the zones assigned to this key  When making broadcasts to the zones including those of other systems: When the audio source for an emergency warning broadcast assigned to the function key is being broadcast to at least one of the own system's zones selected by this unit and/or the zones of the other systems' zone patterns.

**Note**

When making broadcasts to the zones including those of other systems, the status indicator may light green, not yellow depending on the setting contents of the other systems' zone patterns even if the audio source for an emergency warning broadcast assigned to this function key is being broadcast to at least a part of the zones set in the zone patterns assigned to this key.