

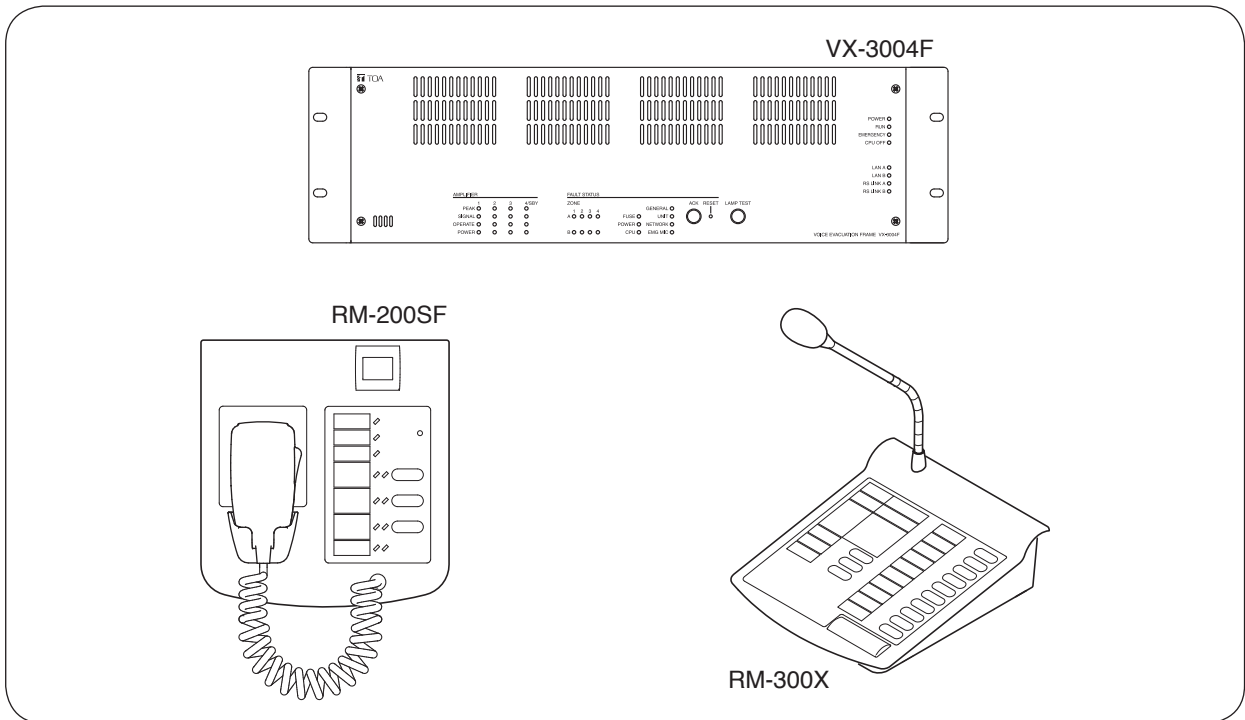

# OPERATING INSTRUCTIONS

## INTEGRATED VOICE EVACUATION SYSTEM VX-3000 SERIES



Thank you for purchasing TOA's Integrated Voice Evacuation System.  
Please carefully follow the instructions in this manual to ensure long, trouble-free use of your equipment.

# TABLE OF CONTENTS

## **Chapter 1 : NOMENCLATURE**

<b>1. VX-3004F, VX-3008F, AND VX-3016F VOICE EVACUATION FRAME</b> .....	1-2
<b>2. RM-200SF FIREMAN'S MICROPHONE AND RM-320F REMOTE MICROPHONE EXTENSION</b> .....	1-5
2.1. RM-200SF .....	1-5
2.2. RM-320F .....	1-7
<b>3. RM-300X REMOTE MICROPHONE AND RM-210F REMOTE MICROPHONE EXTENSION</b> .....	1-8
3.1. RM-300X .....	1-8
3.2. RM-210F .....	1-9

## **Chapter 2 : INDICATOR STATUS OF REMOTE MICROPHONES**

<b>1. RM-200SF FIREMAN'S MICROPHONE AND RM-320F REMOTE MICROPHONE EXTENSION</b> .....	2-2
1.1. Indicator State at the Time of Zone Selection .....	2-2
1.2. Talk Key Indicators .....	2-3
1.3. Indicator State at the Time of Base Pattern Change .....	2-4
1.4. Indicator State at the Time of General-Purpose Broadcast Pattern .....	2-4
1.5. Indicator State at the Time of General/BGM Broadcast .....	2-5
1.6. Indicator State at the Time of RM Broadcast Status Display .....	2-5
1.7. Indicator State at the Time of Lamp Test .....	2-6
1.8. Indicator State at the Time of Failure Output Receipt .....	2-7
1.9. Indicator State at the Time of Failure Output Reset .....	2-8
1.10. Indicator State at the Time of Emergency Broadcast Pattern Start .....	2-9
1.11. Indicator State at the Time of Emergency Broadcast Pattern Stop .....	2-10
1.12. Indicator State at the Time of Emergency Broadcast Pattern Start/Stop .....	2-11
1.13. Indicator State at the Time of Emergency Sequence Stop .....	2-12
1.14. Indicator State at the Time of Emergency Sequence Phase Shift .....	2-13
1.15. Indicator State at the Time of Emergency Reset .....	2-14
1.16. Indicator State at the Time of Audio Monitor .....	2-15
1.17. Indicator State at the Time of Intended Control Input .....	2-15
1.18. Indicator State at the Time of Intended Control Output (Pulse) .....	2-16
1.19. Indicator State at the Time of Intended Control Output (Level) .....	2-16
1.20. Indicator State at the Time of Zone Volume Adjustment (Pulse) .....	2-17
1.21. Indicator State at the Time of Input Volume Adjustment (Pulse) .....	2-18
1.22. Indicator State at the Time of Emergency Warning Broadcast .....	2-19
<b>2. RM-300X REMOTE MICROPHONE AND RM-210F REMOTE MICROPHONE EXTENSION</b> .....	2-20
2.1. Indicator State at the Time of Zone Selection .....	2-20
2.2. Talk Key Indicators .....	2-21
2.3. Indicator State at the Time of Base Pattern Change .....	2-21
2.4. Indicator State at the Time of General-Purpose Broadcast Pattern .....	2-22

2.5. Indicator State at the Time of General/BGM Broadcast .....	2-22
2.6. Indicator State at the Time of RM Broadcast Status Display .....	2-23
2.7. Indicator State at the Time of Lamp Test .....	2-23
2.8. Indicator State at the Time of Failure Output Receipt .....	2-24
2.9. Indicator State at the Time of Failure Output Reset .....	2-25
2.10. Indicator State at the Time of Emergency Broadcast Pattern Start .....	2-26
2.11. Indicator State at the Time of Emergency Broadcast Pattern Stop .....	2-27
2.12. Indicator State at the Time of Emergency Broadcast Pattern Start/Stop .....	2-28
2.13. Indicator State at the Time of Emergency Sequence Stop .....	2-29
2.14. Indicator State at the Time of Emergency Sequence Phase Shift .....	2-30
2.15. Indicator State at the Time of Emergency Reset .....	2-31
2.16. Indicator State at the Time of Audio Monitor .....	2-32
2.17. Indicator State at the Time of Intended Control Input .....	2-32
2.18. Indicator State at the Time of Intended Control Output (Pulse) .....	2-33
2.19. Indicator State at the Time of Intended Control Output (Level) .....	2-33
2.20. Indicator State at the Time of Zone Volume Adjustment (Pulse) .....	2-34
2.21. Indicator State at the Time of Input Volume Adjustment (Pulse) .....	2-35
2.22. Indicator State at the Time of Emergency Warning Broadcast .....	2-36

## **Chapter 3 : OPERATION**

<b>1. BGM AND GENERAL BROADCAST .....</b>	<b>3-2</b>
1.1. Broadcasting from the RM-200SF, RM-300X, RM-320F, and RM-210F .....	3-2
1.2. Assignment Example .....	3-2
1.3. Operation Examples .....	3-3
<b>2. EMERGENCY WARNING BROADCAST .....</b>	<b>3-9</b>
<b>3. EMERGENCY BROADCAST .....</b>	<b>3-10</b>
3.1. Typical System Examples .....	3-10
3.2. Remote Microphone Operation Example .....	3-12
<b>4. MAKING ALL-ZONE EMERGENCY BROADCAST .....</b>	<b>3-15</b>
4.1. Priority Control of the All-Zone Emergency Broadcast .....	3-15
4.2. Making All-zone Emergency Broadcast from the RM-300X .....	3-16
4.3. Making All-zone Emergency Broadcast from the RM-200SF .....	3-17
<b>5. DETECTING FAULT .....</b>	<b>3-18</b>
5.1. Fault Detection Setting Example .....	3-18
5.2. Case Example of Malfunction .....	3-19
5.3. Remote Microphone's Operation Example .....	3-20
5.4. VX-3004F's Operation Example .....	3-21
5.5. Example of Executing the Failure Reception and Failure Reset by Way of the Control Input Terminals .....	3-22
<b>6. LAMP TEST .....</b>	<b>3-23</b>
6.1. Remote Microphone's Operation Example .....	3-23
6.2. VX-3004F's Operation Example .....	3-24
<b>7. OTHER FUNCTIONS .....</b>	<b>3-25</b>
7.1. Audio Monitor .....	3-25
7.2. Intended Control Input Operation .....	3-26

7.3. Intended Control Output Operation (Pulse) .....	3-26
7.4. Intended Control Output Operation (Level) .....	3-27

# ***Chapter 1***

---

## ***NOMENCLATURE***

# 1. VX-3004F, VX-3008F, AND VX-3016F VOICE EVACUATION FRAME

VX-3004F, VX-3008F, and VX-3016F are collectively referred to as “VX-3000F” in this manual.

- The VX-3000F is a unit designed to control the Voice evacuation announcements of the VX-3000 series voice evacuation system.
- It has audio input terminals and can output the amplified audio signals to the speaker lines when the optional power amplifier modules are mounted.
- Compatible with network, the system can be configured in distributed arrangement.

## [Front]

### VX-3004F

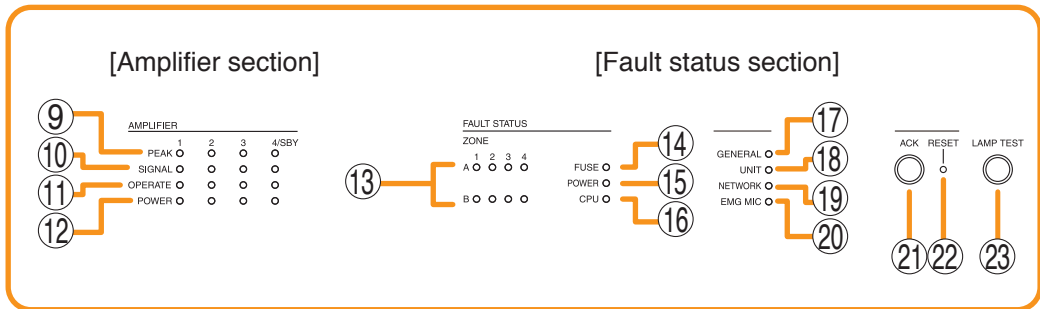
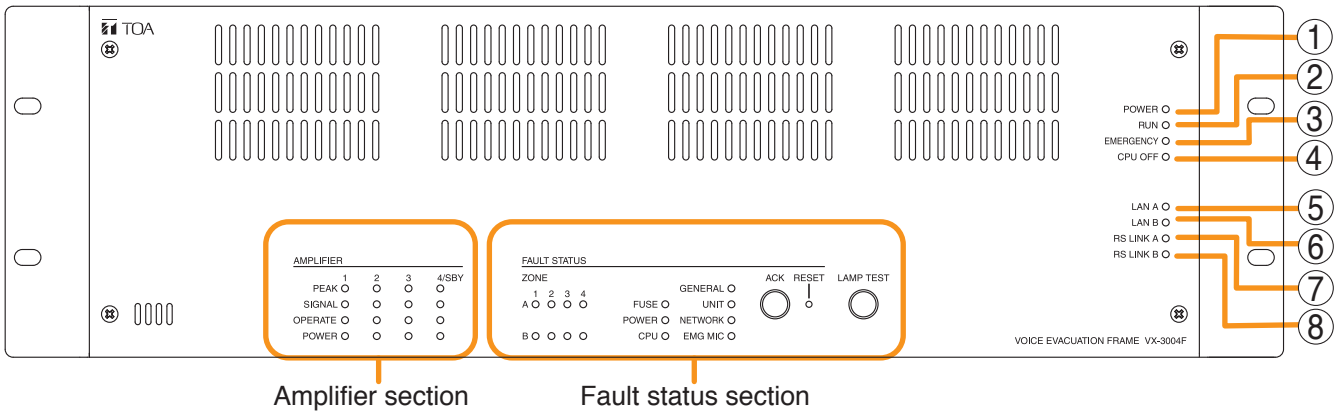

### VX-3008F

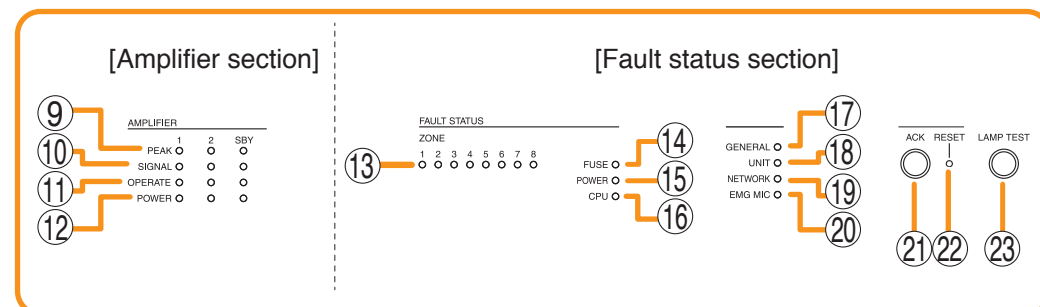
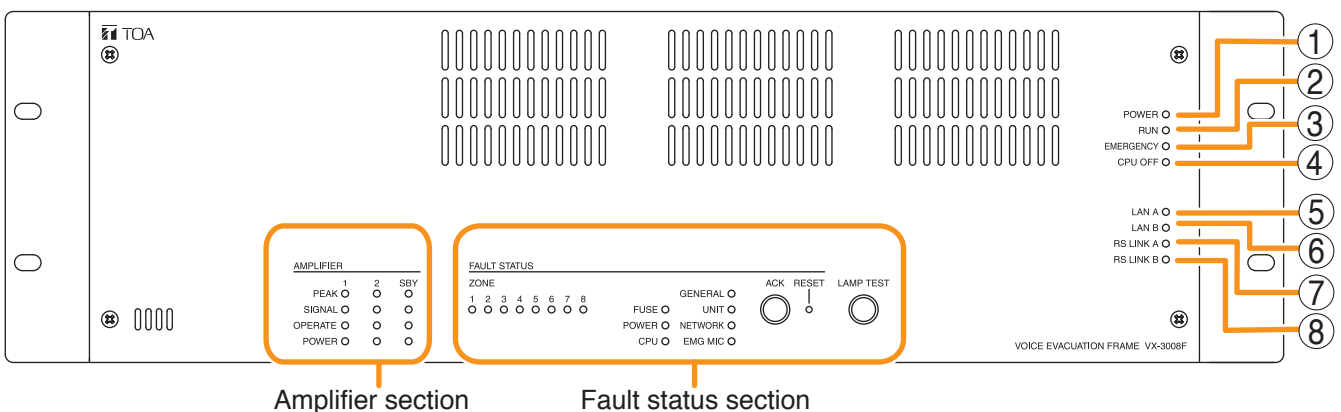

VX-3016F

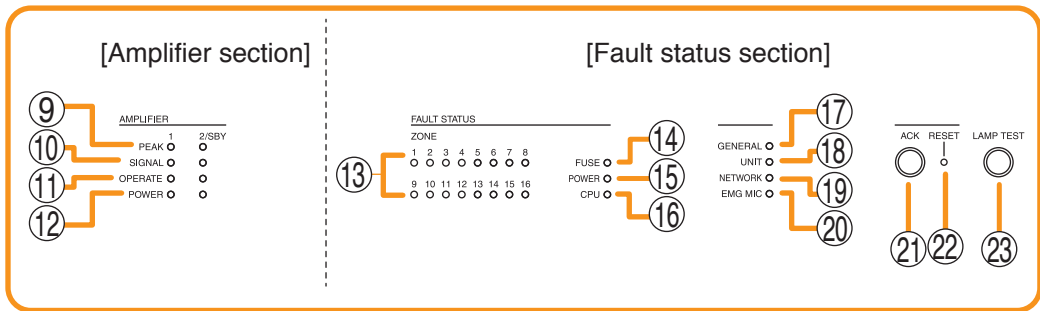
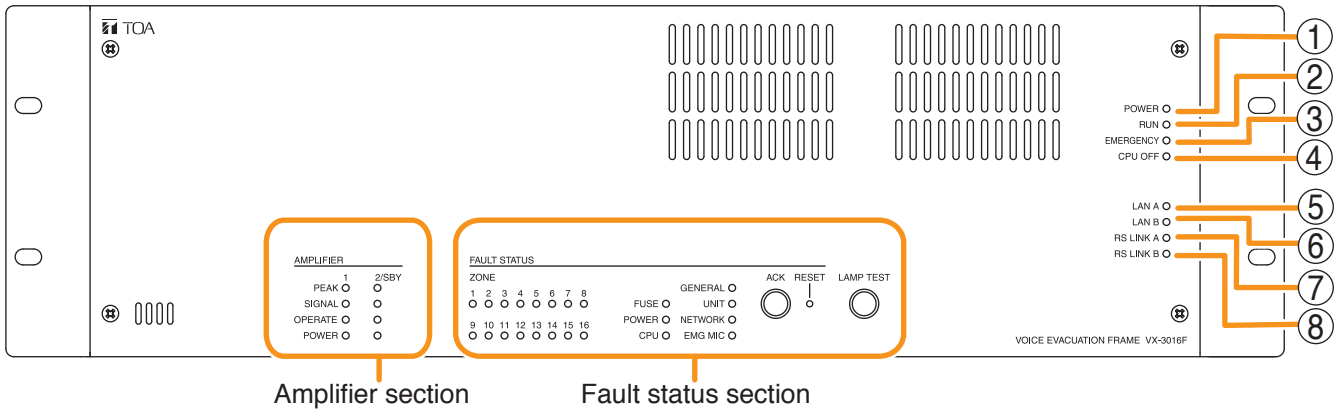

**1. Power indicator (Green)**

Lights when the power is supplied.  
Flashes in standby state.

**2. RUN indicator (Green)**

Normally flashes continuously. Goes off while in a CPU off state (p. 3-15). Also goes off while in standby state\*1.

\*1 A state during power failures or a state that the unit is internally initialized after power-on

**3. Emergency indicator (Red)**

Lights when the VX-3000 system is in an emergency condition or while in a CPU off state (p. 3-15).

**4. CPU off indicator (Red)**

Lights while in a CPU off state (p. 3-15).

**5. LAN A indicator (Green)**

Lights when the LAN link A connector on the rear panel is connected, and flashes during LAN communications.

**6. LAN B indicator (Green)**

Lights when the LAN link B connector on the rear panel is connected, and flashes during LAN communications.

**7. RS link A indicator (Green)**

Lights when the RS link A connector on the rear panel is connected, and flashes while communications are being performed via the RS link A connector.

**8. RS link B indicator (Green)**

Lights when the RS link B connector on the rear panel is connected, and flashes while communications are being performed via the RS link B connector.

**9. Amplifier peak indicators (Red)**

Show the input signal state to the power amplifier when the power amplifier module is installed. The indicator corresponding to the module slot port will light if the input signal level exceeds +0.5 dB\*2. It remains unlit when no power amplifier module is installed.

**10. Amplifier signal indicators (Green)**

Show the input signal state to the power amplifier when the power amplifier module is installed. The indicator corresponding to the module slot port will light if the input signal level exceeds -25 dB\*2. It remains unlit when no power amplifier module is installed.

\*2 0 dB = 1 V

**11. Amplifier operate indicators (Green)**

The indicator corresponding to the module slot port will light or go off depending on the operation state of the power amplifier when the power amplifier module is installed.

Operating status	Indicator status
In-use	Lit
Standby	Unlit
DC fuse blowout	Unlit
Protection* activated	Unlit

\* The built-in protection circuit operates if some irregularities occur inside the amplifier such as abnormal temperature rise or fan failure.

It remains unlit when no power amplifier module is installed.

**12. Amplifier power indicators (Green)**

The indicator corresponding to the module slot port will light or go off depending on the operation state of the power amplifier when the power amplifier module is installed.

Operating status	Indicator status
In-use	Lit
Standby	Lit
DC fuse blowout	Unlit
Protection* activated	Lit

\* The built-in protection circuit operates if some irregularities occur inside the amplifier such as abnormal temperature rise or fan failure.

It remains unlit when no power amplifier module is installed.

**13. Zone fault indicators (Yellow)**

Lights or flashes when the speaker line surveillance function detects 3 types of failures: poor insulation (ground fault), overload (line short), and cable disconnection.

**14. Fuse fault indicator (Yellow)**

Lights or flashes when DC fuse blowout are detected.

**15. Power fault indicator (Yellow)**

Lights or flashes when failures are detected in Power Supply Manager.

**16. CPU fault indicator (Yellow)**

Lights while in a CPU off state (p. 3-15) or when a failure is detected in the VX-3000F.

**17. General fault indicator (Yellow)**

Lights while in a CPU off state (p. 3-15) Lights or flashes when a failure is detected in the system.

**18. Unit fault indicator (Yellow)**

Lights or flashes when a failure is detected in the unit.

**19. Network fault indicator (Yellow)**

Lights or flashes when failures are detected in communications with the other VX-3000F. It also flashes or lights at network setting and when a configuration error occurs.

**20. Emergency microphone fault indicator (Yellow)**

Lights or flashes when failures are detected in Emergency Microphone.

**21. Fault ACK key**

The buzzer will sound and Fault indicator will flashes when a failure is detected in the system. Press this key to stop the buzzer and switches the Fault indicator from flashing to steady on.

**22. Fault reset key**

Pressing this key resets the failure information (the buzzer and fault indicators) for the system.

**23. Lamp test key**

Used to test each indicator on the front panel of the VX-3000F Voice Evacuation Frame. All indicators remain lit and the buzzer sounds as long as this key is pressed.



## 2. RM-200SF FIREMAN'S MICROPHONE AND RM-320F REMOTE MICROPHONE EXTENSION

### 2.1. RM-200SF

- The RM-200SF Fireman's Microphone features 3 function keys, 1 emergency key, 1 talk key, and the indicator lamps associated with these keys. Functions are assigned to the function keys using the VX-3000 Setting Software.
- Specially designed for both emergency and general purpose broadcast applications, the Fireman's Microphone can be used for push-button zone selection and microphone broadcasts.
- VX-3000 setting software permits desired functions to be assigned to individual Function keys (equipped with 2 LED indicators).
- Up to 4 RM-320F Remote Microphone Extension units can be used with each RM-200SF Remote Microphone.
- Up to 2 RM-200SF Fireman's Microphones can be connected within a VX-3000F.
- The CPU switch enables all-zone emergency broadcasts from the RM-200SF Fireman's Microphone, even when the CPU malfunctions.
- Failures of Emergency buttons and signal (both control and audio) path between the microphone (including the internal microphone element) and the VX-3000F are automatically detected.

[Front]

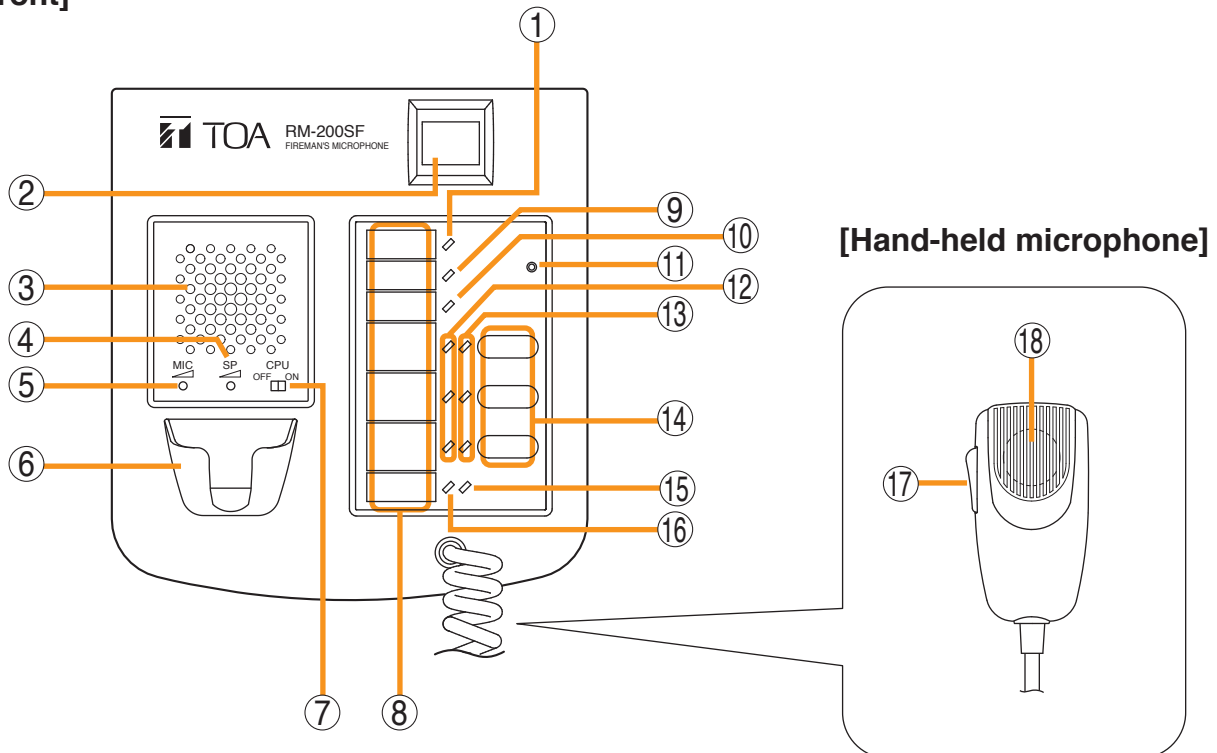

#### 1. Power indicator (Green)

Lights when the power is turned on.

#### 2. Emergency key

Assign emergency activation function to this key using the VX-3000 Setting Software. Lights when the VX-3000F is in an emergency condition.

#### 3. Monitor speaker

Used to monitor current broadcasts.

#### 4. Monitor speaker volume control

Adjusts the volume of the built-in Monitor speaker (3).

#### 5. Microphone volume control

Adjusts the input sensitivity of the Hand-held Microphone.

#### 6. Microphone hanger

Used to hold the unit's Hand-held Microphone.

#### 7. CPU switch

Normally set to ON. (Factory-preset: ON) Setting this switch to OFF in combination with the DIP switch setting on the bottom surface allows the all-zone emergency broadcast to be made using a hand-held microphone by way of analog transmission not via the CPU control.

**8. Indication label insert slot**

The label can be printed using the VX-3000 Setting Software. (See the separate Setting Software Instructions, "PRINTING LABELS FOR REMOTE MICROPHONES.")

**9. Failure indicator (Yellow/Red)**

Flashes yellow if some problem within the system is detected.

This indicator will light yellow if the signal to the VX-3000F or VX-3000F to which the RM-200SF is connected is interrupted for 5 seconds or more. Lights red when the unit is placed in reset state by pressing the Reset Switch (11).

**10. CPU indicator (Red)**

Lights red when any one of the CPU switches on the RM-200SFs connected within the system is set to OFF or when the all-zone emergency broadcasts is being made by any one of the RM-300Xs connected within the system.

**11. Reset switch**

Used to reactivate the RM-200SF unit. Holding down both this switch and the R3 key of the Function keys (14) for 2 seconds or more causes the Failure Indicator (9) to light red, placing the RM-200SF in reset state.

**12. Status indicators (Red/Yellow/Green)**

Light, flash, or go off depending on the current operation state of function keys, failure state or emergency state. (See the Chapter 2.)

**13. Selection indicators (Green)**

Light or go off depending on the current operation state of function keys. (See the Chapter 2.)

**14. Function keys (R1 – R3)**

Positioned in top-down order (R1, R2, R3). Pressing a specific function key executes the function that has been assigned to that key by the VX-3000 Setting Software. Assignment of functions to specific keys is done using the VX-3000 Setting Software. (See the separate Setting Software Instructions, "RM Event Settings.")

**15. Microphone indicator (Green)**

Lights or goes off depending on the current operation state of the Talk key.

**16. Broadcast status indicator (Yellow/Green)**

Lights, flashes, or goes off depending on the current operation state of the Talk key.

**17. Talk key**

Press this key to broadcast a voice announcement. It must be pressed continuously for the duration of the broadcast. The talk key operation method is fixed to "PTT," and can not be changed.

**18. Microphone**

Used for voice announcements.

## 2.2. RM-320F

Each connected RM-320F Extension unit adds 20 Function keys to the base RM-200SF.

### [Front]

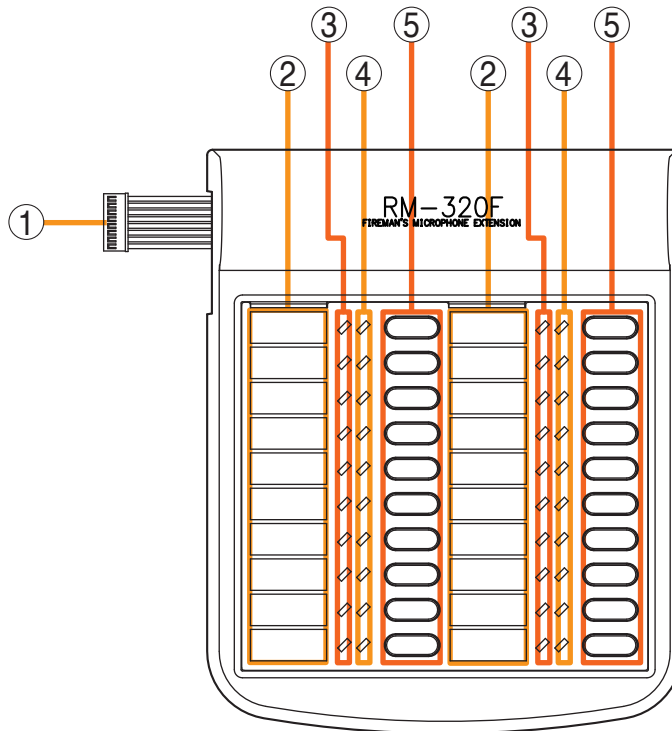

#### 1. Connection cable

Used for connection to the RM-200SF or other RM-320F.

#### 2. Indication label insert slot

The label can be printed using the VX-3000 Setting Software. (See the separate Setting Software Instructions, "PRINTING LABELS FOR REMOTE MICROPHONES.")

#### 3. Status indicators (Red/Yellow/Green)

Light, flash, or go off depending on the current operation state of function keys.

#### 4. Selection indicators (Green)

Light or go off depending on the current operation state of function keys.

#### 5. Function keys (1 – 20)

Keys are numbered from 1 to 10 from upper left to bottom and from 11 to 20 from upper right to bottom.

Pressing a specific function key executes the function that has been assigned to that key by the VX-3000 Setting Software. Assignment of functions to specific keys is done using the VX-3000 Setting Software.

(See the separate Setting Software Instructions, "RM Event Settings.")

### 3. RM-300X REMOTE MICROPHONE AND RM-210F REMOTE MICROPHONE EXTENSION

#### 3.1. RM-300X

- The RM-300X Remote Microphone features 13 function keys, 1 covered key, 1 talk key, and the indicator lamps associated with these. Functions are assigned to the function keys using the VX-3000 Setting Software.
- VX-3000 setting software permits desired functions to be assigned to individual Function keys (equipped with 2 LED indicators).
- Connecting RM-210F Remote Microphone Extension (maximum 7) to the RM-300X expands the number of function keys and indicators in blocks of 10.
- Up to 8 RM-300X Remote Microphones can be connected within a VX-3000F.
- The DIP switch setting enables all-zone emergency broadcasts from the RM-300X Remote Microphone, even when the CPU malfunctions.

[Top]

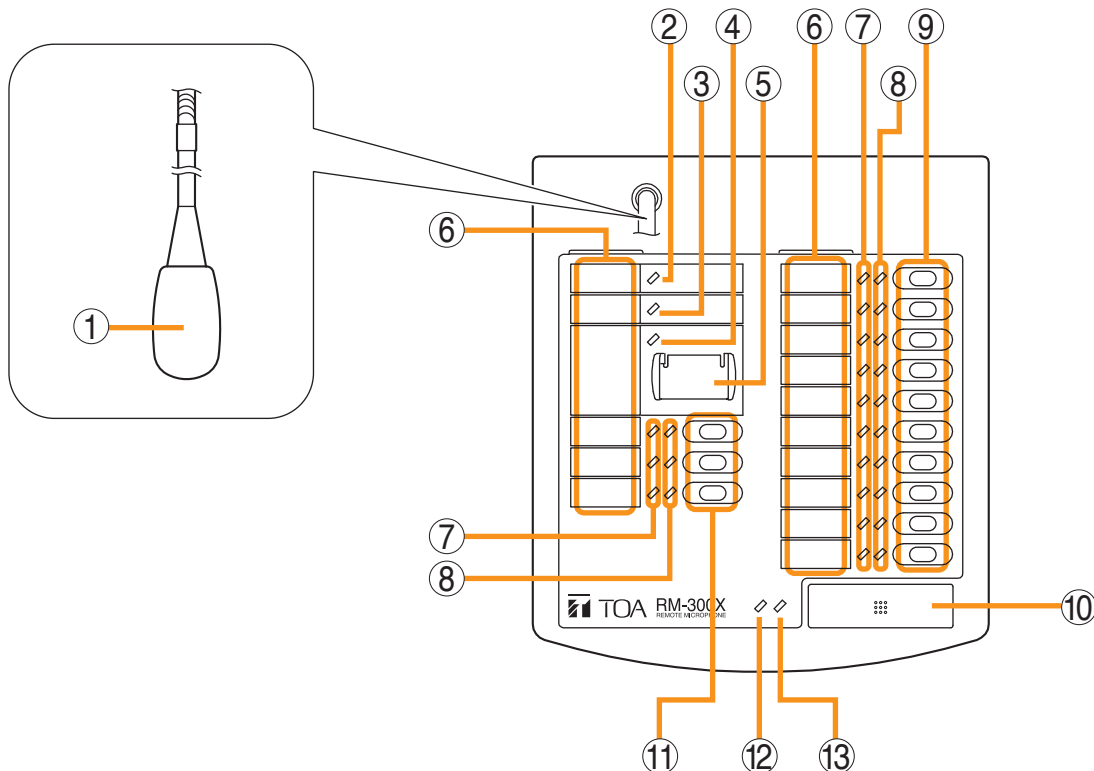

#### 1. Microphone

Used for voice announcements.

#### 2. Power indicator (Green)

Lights when the power is turned on.

#### 3. Failure indicator (Yellow/Red)

Flashes yellow if some problem within the system is detected.

This indicator will light yellow if the signal to the VX-3000F or VX-3000F to which the RM-300X is connected is interrupted for 5 seconds or more.

This indicator will light red while the all-zone emergency broadcasts is being made (p. 3-15) or the RM-300X is in the reset process.

#### 4. Emergency indicator (Red)

Lights when the VX-3000F is in an emergency condition.

#### 5. Emergency/all-zone emergency broadcast key (Covered)

When the Emergency Broadcast Pattern Start function has been assigned to this key by the VX-3000 Setting Software, pressing it activates the emergency broadcast from the VX-3000F.

Independently of settings made by the VX-3000 Setting Software, holding down this key for 4 seconds or more in combination with DIP switch (14) setting causes the CPU to be bypassed, enabling the all-zone emergency broadcast to be made by way of analog transmissions. (See p. 3-15.)

#### 6. Indication label insert slots

Labels can be printed using the VX-3000 Setting Software. (See the separate Setting Software Instructions, "PRINTING LABELS FOR REMOTE MICROPHONES.")

**7. Status indicators (Red/Yellow/Green)**

Light, flash, or go off depending on the current operation state of function keys, failure state or emergency state. (See the Chapter 2.)

**8. Selection indicators (Green)**

Light or go off depending on the current operation state of function keys. (See the Chapter 2.)

**9. Function keys (R1 – R10)**

Positioned in top-down order (R1, R2 ... R10). Pressing a specific function key executes the function that has been assigned to that key by the VX-3000 Setting Software.

Assignment of functions to specific keys is done using the VX-3000 Setting Software. (See the separate Setting Software Instructions, "RM Event Settings.")

**10. Talk Key**

Press this key to broadcast a voice announcement. If the Talk key is set to "PTT" ("press-to-talk") mode, then it must be pressed continuously for the duration of the broadcast.

If the Talk key is set to "Lock" mode, then it must

be pressed once to turn the microphone on at the beginning of a broadcast, then pressed again to turn the microphone off once the broadcast is finished.

The microphone can also be set to sound a chime at the beginning and/or end of each broadcast.

The Talk key mode ("PTT" or "Lock") and the chime function are set using the VX-3000 Setting Software. (See the separate Setting Software Instructions, "Unit Configuration Setting.")

**11. Function keys (L1 – L3)**

Positioned in top-down order (L1, L2, L3).

These keys operate in the same manner as the Function keys (R1 – R10) (9).

**12. Broadcast status indicator (Yellow/Green)**

Lights, flashes, or goes off depending on the current operation state of the Talk key.

**13. Microphone indicator (Green)**

Lights or goes off depending on the current operation state of the Talk key. Flashes while the chime is being activated.

**3.2. RM-210F**

Each connected RM-210F Extension unit adds 10 Function keys to the base RM-300X.

[Top]

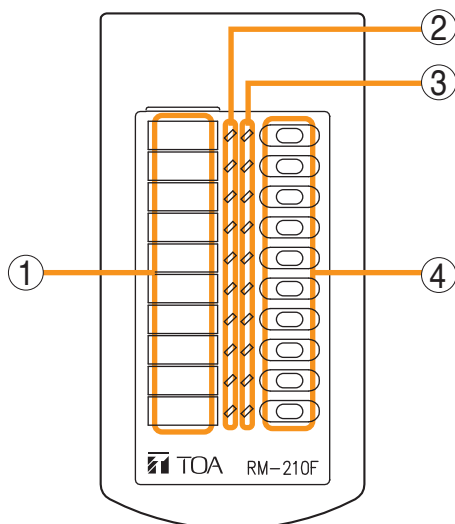
**1. Indication label insert slot**

The label can be printed using the VX-3000 Setting Software. (See the separate Setting Software Instructions, "PRINTING LABELS FOR REMOTE MICROPHONES.")

**2. Status indicators (Red/Yellow/Green)**

Light, flash, or go off depending on the current operation state of function keys.

**3. Selection indicators (Green)**

Light or go off depending on the current operation state of function keys.

**4. Function keys (1 – 10)**

Positioned in top-down order (1, 2 ... 10).

Pressing a specific function key executes the function that has been assigned to that key by the VX-3000 Setting Software.

Assignment of functions to specific keys is done using the VX-3000 Setting Software. (See the separate Setting Software Instructions, "RM Event Settings.")

# ***Chapter 2***

---

## ***INDICATOR STATUS OF REMOTE MICROPHONES***

# 1. RM-200SF FIREMAN’S MICROPHONE AND RM-320F REMOTE MICROPHONE EXTENSION

## 1.1. Indicator State at the Time of Zone Selection

When a zone selection (pattern or individual) function has been assigned to a function key, the 2 indicators to the left of the key indicate its zone selection and broadcast status.

**Note**

For instructions on assigning functions to function keys, see the separate Setting Software Instructions, "EVENT SETTINGS."

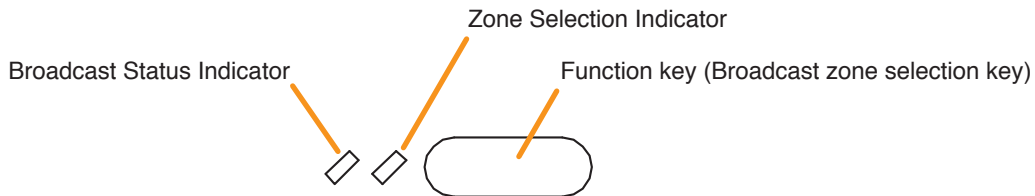





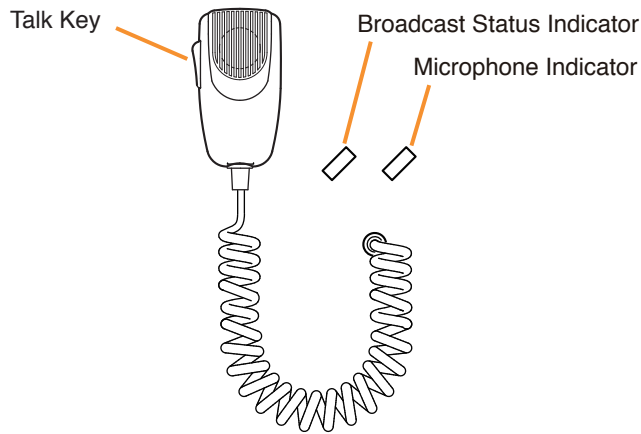

Indicator meanings are as follows:

Indicator	Status	Meaning
Zone Selection Indicator	Unlit	No zone selected
	Lights green	Zone selected
Broadcast Status Indicator	Unlit	Zones assigned to this Broadcast Zone Selection key not in use or BGM broadcast in progress
	Flashes green	A part of zones or the entire zone assigned to this Broadcast Zone Selection key is occupied by a broadcast from another device (secondary Remote Microphone, or general EV message), or a part of zones is engaged by a broadcast from the primary Remote Microphone (RM-200SF).
	Lights yellow	All the zones selected by this Broadcast Zone Selection key on the primary Remote Microphone are engaged by a broadcast from the primary Remote Microphone.
	Flashes yellow	All the zones assigned to this Broadcast Zone Selection key are engaged by a broadcast from the Secondary Emergency Remote Microphone.
	Lights red	All the zones assigned to this Broadcast Zone Selection key are engaged by an evacuation message.
	Flashes red	All the zones assigned to this Broadcast Zone Selection key are engaged by an alert message.
	Lights green	All the zones assigned to this Broadcast Zone Selection key are engaged by a restoration message.

## 1.2. Talk Key Indicators



The meanings of the 2 indicators located below the status and selection indicators are as follows:

Indicator	Status	Meaning
Microphone Indicator	Unlit 	Microphone not in use
	Lights green 	Microphone in use
	Flashes green 	Chime broadcast in progress from the primary Remote Microphone.
Broadcast Status Indicator	Unlit 	Zone not in use (microphone announcement possible)
	Flashes green 	A part of zones or the entire zone selected by the primary Remote Microphone is occupied by a broadcast from another device (secondary Remote Microphone, chime, etc.), or a broadcast from the primary Remote Microphone is in progress in a part of the zones selected by the primary Remote Microphone.
	Lights yellow 	All zones selected by the primary Remote Microphone are engaged by a broadcast from the primary Remote Microphone.



### 1.3. Indicator State at the Time of Base Pattern Change



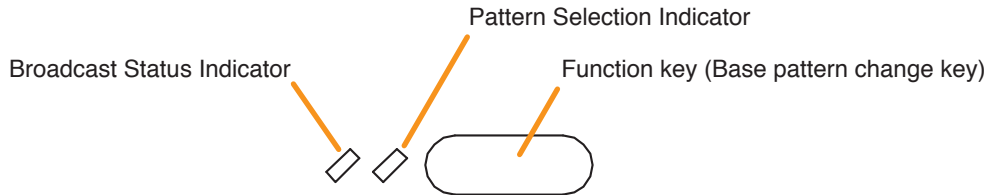

When a Base pattern change function has been assigned to a function key, the 2 indicators to the left of the key indicate its pattern selection and broadcast status.

**Note**

For instructions on assigning functions to function keys, see the separate Setting Software Instructions, "EVENT SETTINGS."



The meanings of the 2 indicators next to the Function key are as follows:

Indicator	Status	Meaning
Pattern Selection Indicator	Unlit 	When the function key is not pressed
	Lights green 	When the function key is pressed (Lights briefly, then goes off)
Broadcast Status Indicator	Unlit 	When the Base pattern assigned to the function key is not being broadcast
	Lights yellow 	When the Base pattern assigned to the function key is being broadcast (including broadcasts activated by other devices)

### 1.4. Indicator State at the Time of General-Purpose Broadcast Pattern



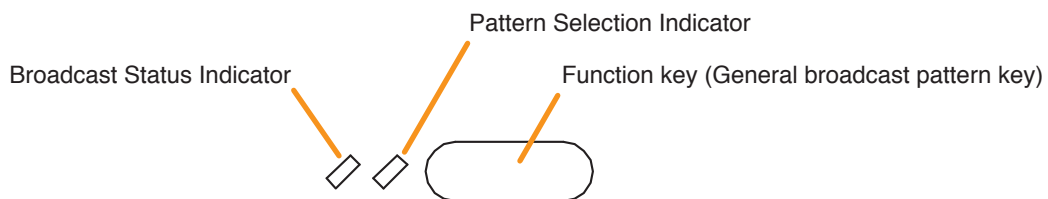

When a general-purpose broadcast pattern function has been assigned to a function key, the 2 indicators to the left of the key indicate its pattern selection and broadcast status.

**Note**

For instructions on assigning functions to function keys, see the separate Setting Software Instructions, "EVENT SETTINGS."



The meanings of the 2 indicators next to the Function key are as follows:

Indicator	Status	Meaning
Pattern Selection Indicator	Unlit 	When the function key is not pressed
	Lights green 	When the function key is pressed
Broadcast Status Indicator	Unlit 	When the broadcast pattern assigned to the function key is not being broadcast
	Flashes yellow 	When the broadcast pattern assigned to the function key is being broadcast

### 1.5. Indicator State at the Time of General/BGM Broadcast



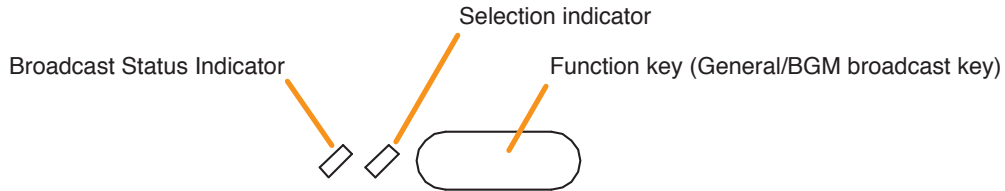

When a general/BGM broadcast function has been assigned to a function key, the 2 indicators to the left of the key indicate its selection and broadcast statuses.

**Note**

For instructions on assigning functions to function keys, see the separate Setting Software Instructions, "EVENT SETTINGS."



The meanings of the 2 indicators next to the Function key are as follows:

Indicator	Status	Meaning
Selection Indicator	Unlit 	When the function key is not pressed
	Lights green 	When the unit is brought in general/BGM broadcast by pressing the function key
Broadcast Status Indicator	Unlit 	When a general/BGM broadcast assigned to the function key is not activated
	Lights green 	When a general/BGM broadcast assigned to the function key is being broadcast from the equipment other than the Remote Microphone
	Lights yellow 	When a general/BGM broadcast assigned to the function key is being broadcast from the primary Remote Microphone or other Remote Microphone

### 1.6. Indicator State at the Time of RM Broadcast Status Display



The Broadcast status indicator to the left of the Function key indicates the current broadcast status of other Remote Microphone.

**Note**

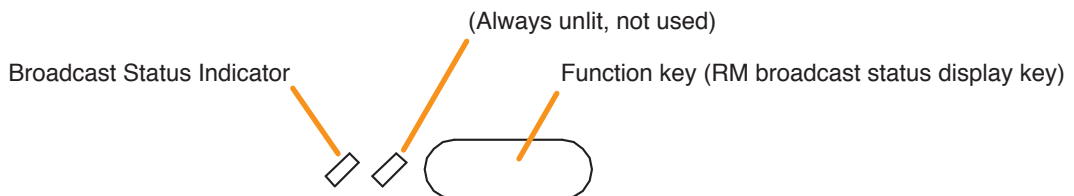
For instructions on assigning functions to function keys, see the separate Setting Software Instructions, "EVENT SETTINGS."



The meanings of the 2 indicators next to the Function key are as follows:

Indicator	Status	Meaning
Broadcast Status Indicator	Unlit 	When the Remote Microphone assigned to the function key is not engaged in broadcasting
	Lights yellow 	When the Remote Microphone assigned to the function key is engaged in broadcasting

### 1.7. Indicator State at the Time of Lamp Test



When the lamp test function has been assigned to the Function key, the 2 indicators to the left of the key indicate the running status of the lamp test. Pressing the Lamp test key causes all indicators on the primary Remote Microphone to light, and the built-in buzzer to sound.

**Notes**

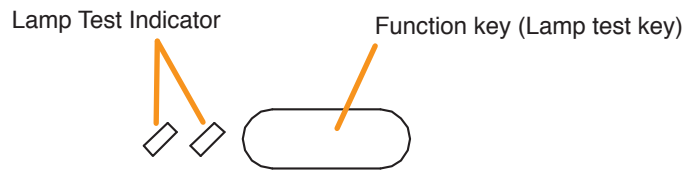
- For instructions on setting the failure detection function, see the separate Setting Software Instructions, "BASIC SETTINGS."
- For instructions on assigning functions to function keys, see the separate Setting Software Instructions, "EVENT SETTINGS."



The meanings of the 2 indicators next to the Function key are as follows:

Indicator	Status	Meaning
Lamp Test Indicator	Unlit 	When the function key is not pressed
	Lights yellow and green 	Lamp test has been executed by pressing the function key.

### 1.8. Indicator State at the Time of Failure Output Receipt

When the VX-3000 system is set to enable "Surveillance function," the failure output receipt function can be assigned to a function key.



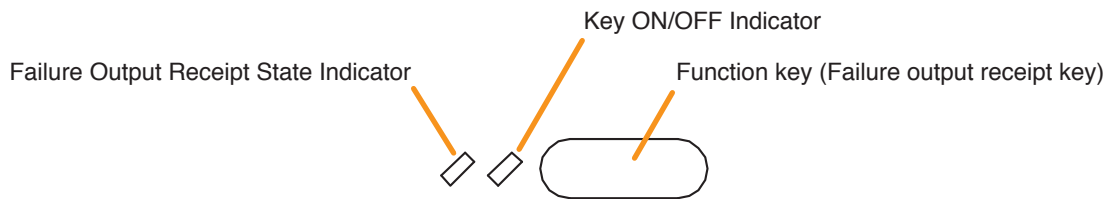

When the failure output receipt function has been assigned to the Function key, the 2 indicators to the left of the key indicate the occurrence and acknowledgement status of the failure output pattern.

**Notes**

- For instructions on setting the surveillance function, see the separate Setting Software Instructions, "BASIC SETTINGS."
- For instructions on assigning functions to function keys, see the separate Setting Software Instructions, "EVENT SETTINGS."



The meanings of the 2 indicators next to the Function key are as follows:

Indicator	Status	Meaning
Key ON/OFF Indicator	Unlit 	When the function key is not pressed
	Lights green 	When the function key is pressed (as long as it is pressed)
Failure Output Receipt State Indicator	Flashes yellow 	When the failure output pattern assigned to the function key has occurred.
	Lights yellow 	Failure Output Pattern has been acknowledged after pressing the function key.

### 1.9. Indicator State at the Time of Failure Output Reset

When the VX-3000 system is set to enable "Surveillance function," the failure output reset function can be assigned to a function key.



When the failure output reset function has been assigned to the Function key, the failure status indicator can be reset by pressing the key. The indicator to the left of the key lights only when the key is pressed.

**Notes**

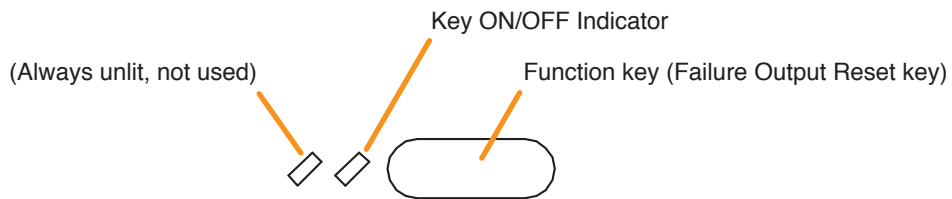
- For instructions on setting surveillance function, see the separate Setting Software Instructions, "BASIC SETTINGS."
- For instructions on assigning functions to function keys, see the separate Setting Software Instructions, "EVENT SETTINGS."



The meanings of the 2 indicators next to the Function key are as follows:

Indicator	Status	Meaning
Key ON/OFF Indicator	Unlit 	When the function key is not pressed
	Lights green 	When the function key is pressed (as long as it is pressed)

### 1.10. Indicator State at the Time of Emergency Broadcast Pattern Start

When the system is set to "Emergency," the emergency broadcast pattern start function can be assigned to the Emergency key or function key.

Pressing the function-assigned key causes the emergency broadcast to start.

Assigning this function to the Emergency key causes the key to light or go off, indicating the emergency state of the VX-3000 system.

Meanwhile, when a function key is assigned this function, the 2 indicators next to the key indicate the emergency start and emergency states of the VX-3000 system.



**Notes**

- For the emergency function settings, see the separate Setting Software Instructions, "BASIC SETTINGS."
- For instructions on assigning functions to the emergency key and function keys, see the separate Setting Software Instructions, "EVENT SETTINGS."

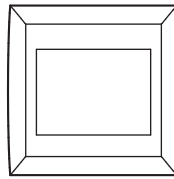
**[When assigned to the Emergency key]**





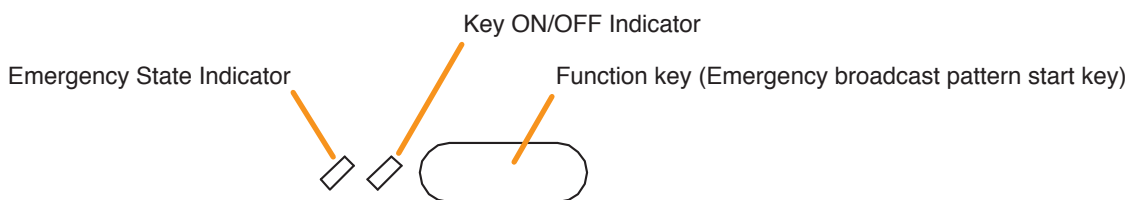

Emergency key

Indicator	Status	Meaning
Emergency Key Indicator	Unlit 	The VX-3000 system is not in an emergency condition.
	Lights red 	The Emergency Broadcast Pattern is started by pressing this Emergency key or the VX-3000 system is in an emergency condition.

**[When assigned to the function key]**



The meanings of the 2 indicators next to the Function key are as follows:

Indicator	Status	Meaning
Key ON/OFF Indicator	Unlit 	When the function key is not pressed
	Lights green 	When the function key is pressed (as long as it is pressed)
Emergency State Indicator	Unlit 	Emergency Broadcast Patterns assigned to the function key are not broadcast.
	Flashes red 	A part of Emergency Broadcast Patterns assigned to the function key is broadcast.
	Lights red 	All Emergency Broadcast Patterns assigned to the function key are broadcast.

### 1.11. Indicator State at the Time of Emergency Broadcast Pattern Stop

When the system is set to "Emergency," the emergency broadcast pattern stop function can be assigned to the Function key.



Pressing the function-assigned key causes the emergency broadcast pattern to stop. The indicator to the left of the key lights only when the key is pressed.

**Notes**

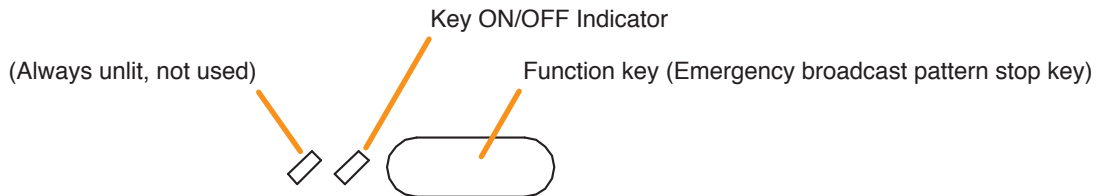
- For the emergency function settings, see the separate Setting Software Instructions, "BASIC SETTINGS."
- For instructions on assigning functions to the function keys, see the separate Setting Software Instructions, "EVENT SETTINGS."



The meanings of the 2 indicators next to the Function key are as follows:

Indicator	Status	Meaning
Key ON/OFF Indicator	Unlit 	When the function key is not pressed
	Lights green 	When the function key is pressed (as long as it is pressed)

### 1.12. Indicator State at the Time of Emergency Broadcast Pattern Start/Stop

When the system is set to "Emergency," the emergency broadcast pattern start function can be assigned to the Emergency key or function key.

When the Emergency Broadcast Pattern set to the function-assigned key is OFF, pressing this key activates the emergency broadcast.

When the Emergency Broadcast Pattern set to the function-assigned key is ON, pressing this key stops the corresponding emergency broadcast pattern or returns the emergency mode to the normal state. The selection of which operation to perform depends on the setting.

Assigning this function to the Emergency key causes the key to light or go off, indicating the emergency state of the VX-3000 system.

Meanwhile, when a function key is assigned this function, the 2 indicators next to the key indicate the emergency start and emergency states of the VX-3000 system.



**Notes**

- For the emergency function settings, see the separate Setting Software Instructions, "BASIC SETTINGS."
- For instructions on assigning functions to the covered key and function keys, see the separate Setting Software Instructions, "EVENT SETTINGS."

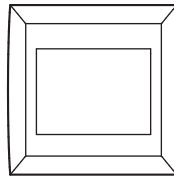
**[When assigned to the Emergency key]**





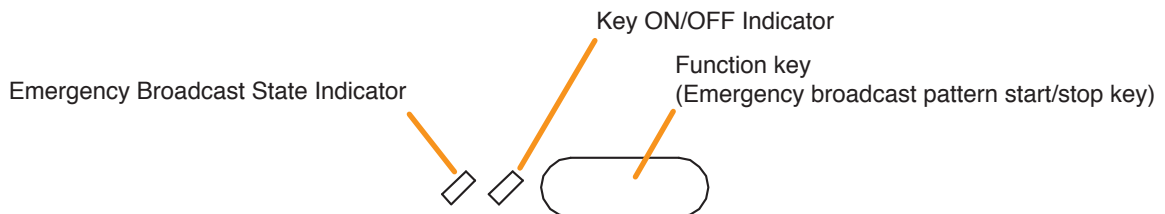

Emergency key

Indicator	Status	Meaning
Emergency Key Indicator	Unlit 	The VX-3000 system is not in an emergency condition.
	Lights red 	The Emergency Broadcast Pattern is started by pressing this Emergency key or the VX-3000 system is in an emergency condition.

**[When assigned to the function key]**



The meanings of the 2 indicators next to the Function key are as follows:

Indicator	Status	Meaning
Key ON/OFF Indicator	Unlit 	When the function key is not pressed
	Lights green 	When the function key is pressed (as long as it is pressed)
Emergency Broadcast State Indicator	Unlit 	Emergency Broadcast Pattern assigned to the function key is not broadcast.
	Lights green 	Restoration Message broadcast assigned to the function key is being activated.
	Lights red 	Emergency Broadcast Pattern assigned to the function key is broadcast.



### 1.13. Indicator State at the Time of Emergency Sequence Stop

When the system is set to "Emergency," the emergency sequence stop function can be assigned to the Function key.



Pressing the function-assigned key causes all the emergency broadcast patterns including the set emergency sequence to stop. The indicator to the left of the key lights only when the key is pressed.

**Notes**

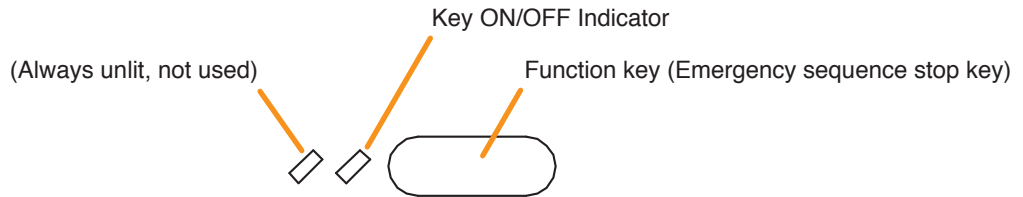
- For the emergency function settings, see the separate Setting Software Instructions, "BASIC SETTINGS."
- For instructions on assigning functions to the function keys, see the separate Setting Software Instructions, "EVENT SETTINGS."



The meanings of the 2 indicators next to the Function key are as follows:

Indicator	Status	Meaning
Key ON/OFF Indicator	Unlit 	When the function key is not pressed
	Lights green 	When the function key is pressed (as long as it is pressed)

### 1.14. Indicator State at the Time of Emergency Sequence Phase Shift

When the system is set to "Emergency," the emergency sequence phase shift function can be assigned to a function key.

Pressing the function-assigned key causes the set emergency sequence to shift to the next phase.



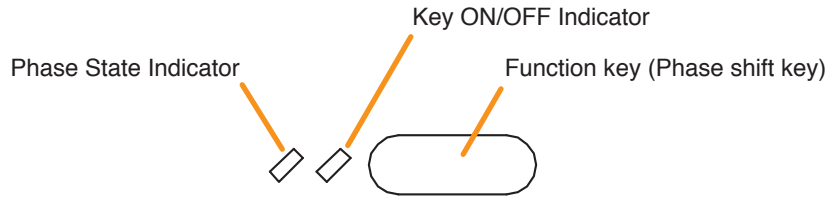

The 2 indicators next to the Function key indicate the emergency sequence phase state.

**Notes**

- For the emergency function settings, see the separate Setting Software Instructions, "BASIC SETTINGS."
- For instructions on assigning functions to function keys, see the separate Setting Software Instructions, "EVENT SETTINGS."



The meanings of the 2 indicators next to the Function key are as follows:

Indicator	Status	Meaning
Key ON/OFF Indicator	Unlit 	When the function key is not pressed
	Lights green 	When the function key is pressed (as long as it is pressed)
Phase State Indicator	Lights green 	Emergency sequence Phase 1 is assigned to the function key.
	Flashes green 	Emergency sequence Phase 2 is assigned to the function key.
	Unlit 	Emergency sequence Phase 3 is assigned to the function key.

### 1.15. Indicator State at the Time of Emergency Reset



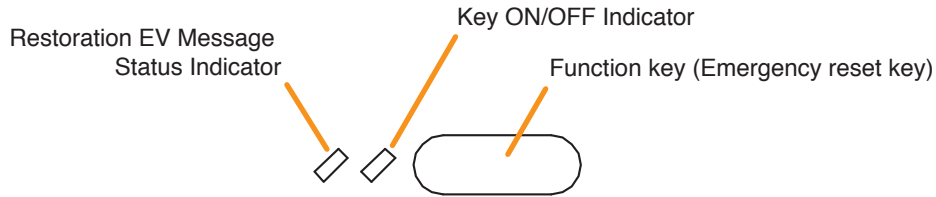

When the system is set to "Emergency," the emergency reset function can be assigned to the Function key. Pressing the function-assigned key causes all the activated emergency broadcast patterns to stop, allowing the emergency broadcast status to be reset after the restoration EV message broadcast completion. The 2 indicators next to the Function key indicate the emergency reset state.

**Notes**

- For the emergency function settings, see the separate Setting Software Instructions, "BASIC SETTINGS."
- For instructions on assigning functions to function keys, see the separate Setting Software Instructions, "EVENT SETTINGS."



The meanings of the 2 indicators next to the Function key are as follows:

Indicator	Status	Meaning
Key ON/OFF Indicator	Unlit 	When the function key is not pressed
	Lights green 	When the function key is pressed (as long as it is pressed)
Restoration EV Message Status Indicator	Unlit 	Restoration EV Message broadcast assigned to the function key is being stopped.
	Lights green 	Restoration EV Message broadcast assigned to the function key is being activated.

### 1.16. Indicator State at the Time of Audio Monitor





When an audio monitor function has been assigned to a function key, the 2 indicators to the left of the key indicate its selection and audio monitor statuses.

**Note**

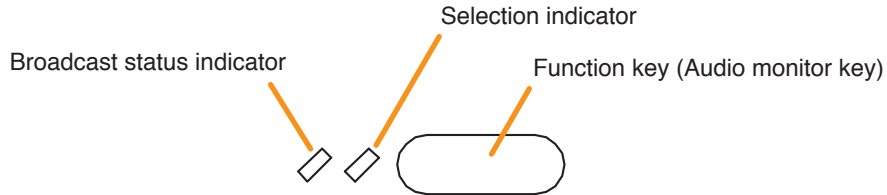
Only one remote microphone can be used for audio monitoring even when 2 or more remote microphones are connected to a single VX-3000F.

Only the remote microphone of which Audio monitor key is pressed most recently is effective for audio monitoring, causing other remote microphone engaged in monitoring to be interrupted.



Indicator	Status	Meaning
Selection indicator	Unlit 	When the function key is not pressed
	Lights green 	When the function key is pressed
Broadcast status indicator	Unlit 	When no broadcast is made to the zone assigned to this function key
	Lights green 	When audio signals are broadcast to the zone assigned to this function key while the function key is held down

### 1.17. Indicator State at the Time of Intended Control Input

When an intended control input function has been assigned to a function key, the 2 indicators to the left of the key indicate its selection and control statuses.





**Note**

Operation may become invalid even if you press the function key when the Control status indicator is lighting. This is such a case when the control input is placed in Active state by other device.

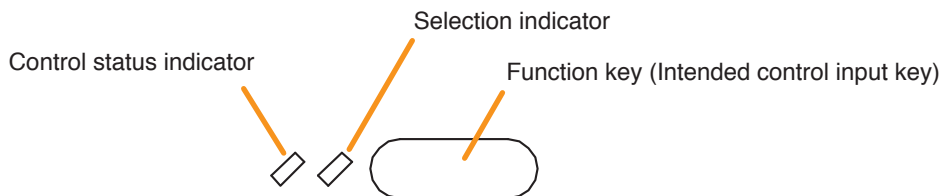
Wait until the Control status indicator goes off, then press the function key again.

Function key operation is always active as long as the Control status indicator is unlit.



Indicator	Status	Meaning
Selection indicator	Unlit 	When the function key is not pressed
	Lights green 	When the function key is pressed
Control status indicator	Unlit 	When the control input assigned to this function key is in Inactive* state
	Lights yellow 	When the control input assigned to this function key is in Active* state

\* When the control input polarity is set to "NO" in the Event setting, the function key becomes Active while the control input is closed, and becomes Inactive when it is open.

Conversely, when the polarity is set to "NC," the function key becomes Active while the control input is open, and becomes Inactive when it is closed.





### 1.18. Indicator State at the Time of Intended Control Output (Pulse)

When the intended control output (pulse) function is assigned to the function key, pressing this key turns ON the preset control output. It is turned OFF when this key is pressed again. When an intended control output (pulse) function has been assigned to a function key, the 2 indicators to the left of the key indicate its selection and control statuses.

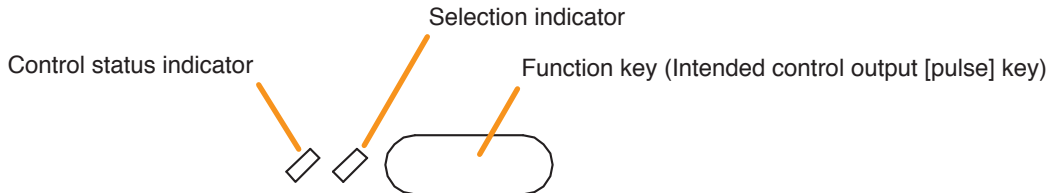
**Note**

Operation may become invalid even if you press the function key when the Control status indicator is lighting. This is such a case when the Control output pattern is being activated by other Event. Wait until the Control status indicator goes off, then press the function key again. Function key operation is always active as long as the Control status indicator is unlit.



Indicator	Status	Meaning
Selection indicator	Unlit 	When the function key is not pressed
	Lights green 	When the function key is pressed
Control status indicator	Unlit 	When the Control output pattern assigned to this function key is not activated
	Lights yellow 	When the Control output pattern assigned to this function key is being activated





### 1.19. Indicator State at the Time of Intended Control Output (Level)

When the intended control output (level) function is assigned to the function key, the preset control output is turned ON while this key is held down. It is turned OFF when this key is released. When an intended control output (level) function has been assigned to a function key, the 2 indicators to the left of the key indicate its selection and control statuses.

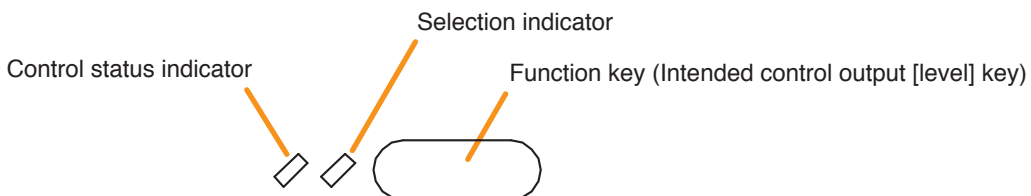
**Note**

Operation may become invalid even if you press the function key when the Control status indicator is lighting. This is such a case when the Control output pattern is being activated by other Event. Wait until the Control status indicator goes off, then press the function key again. Function key operation is always active as long as the Control status indicator is unlit.



Indicator	Status	Meaning
Selection indicator	Unlit 	When the function key is not pressed
	Lights green 	When the function key is pressed (as long as it is pressed)
Control status indicator	Unlit 	When the Control output pattern assigned to this function key is not activated
	Lights yellow 	When the Control output pattern assigned to this function key is being activated

### 1.20. Indicator State at the Time of Zone Volume Adjustment (Pulse)



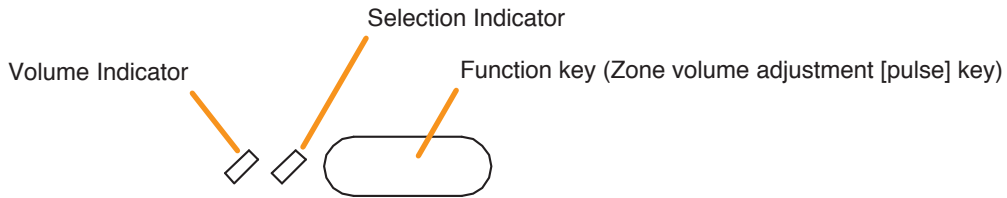

When the Zone volume adjustment (Pulse) function is assigned to the function key, pressing this key increases or decreases the volume level of the preset zone by the set amount. Sound adjustment status can be checked by the indicators to the left of the function key.

**Note**

For instructions on assigning functions to function keys, see the separate Setting Software Instructions, "EVENT SETTINGS."



The meanings of the 2 indicators next to the Function key are as follows:

Indicator	Status	Meaning
Selection indicator	Unlit 	When the function key is not pressed
	Lights green 	When the function key is pressed (as long as it is pressed)
Volume Indicator	Unlit 	In the case the set value* <sup>1</sup> of the volume adjustment is positive (volume increase): When the current volume adjustment value of the zone assigned to this key is less than the initial value* <sup>2</sup>  In the case the set value* <sup>1</sup> of the volume adjustment is negative (volume decrease): When the current volume adjustment value of the zone assigned to this key is greater than the initial value* <sup>2</sup>
	Lights green 	In the case the set value* <sup>1</sup> of the volume adjustment is positive (volume increase): When the current volume adjustment value of the zone assigned to this key is greater than the initial value* <sup>2</sup>  In the case the set value* <sup>1</sup> of the volume adjustment is negative (volume decrease): When the current volume adjustment value of the zone assigned to this key is less than the initial value* <sup>2</sup>

\*1 Value set in "Event setting" of the VX-3000 Setting Software.

\*2 Volume set in "Sound settings (output)" of the VX-3000 Setting Software.

### 1.21. Indicator State at the Time of Input Volume Adjustment (Pulse)



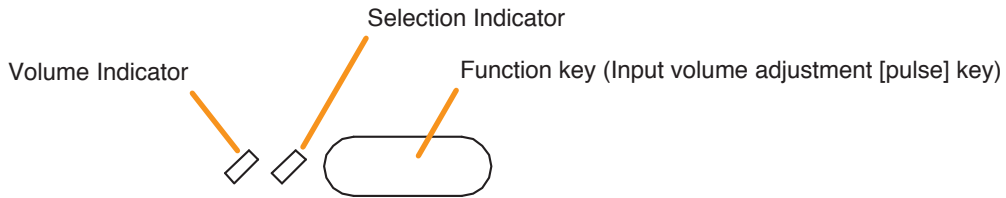

When the Input volume adjustment (Pulse) function is assigned to the function key, pressing this key increases or decreases the volume level of the preset Input channel by the set amount. Sound adjustment status can be checked by the indicators to the left of the function key.

**Note**

For instructions on assigning functions to function keys, see the separate Setting Software Instructions, "EVENT SETTINGS."



The meanings of the 2 indicators next to the Function key are as follows:

Indicator	Status	Meaning
Selection indicator	Unlit 	When the function key is not pressed
	Lights green 	When the function key is pressed (as long as it is pressed)
Volume Indicator	Unlit 	In the case the set value* <sup>1</sup> of the volume adjustment is positive (volume increase): When the current volume adjustment value of the input channel assigned to this key is less than the initial value* <sup>2</sup>  In the case the set value* <sup>1</sup> of the volume adjustment is negative (volume decrease): When the current volume adjustment value of the input channel assigned to this key is greater than the initial value* <sup>2</sup>
	Lights green 	In the case the set value* <sup>1</sup> of the volume adjustment is positive (volume increase): When the current volume adjustment value of the input channel assigned to this key is greater than the initial value* <sup>2</sup>  In the case the set value* <sup>1</sup> of the volume adjustment is negative (volume decrease): When the current volume adjustment value of the input channel assigned to this key is less than the initial value* <sup>2</sup>

\*<sup>1</sup> Value set in "Event setting" of the VX-3000 Setting Software.

\*<sup>2</sup> Volume set in "Sound settings (input)" of the VX-3000 Setting Software.

### 1.22. Indicator State at the Time of Emergency Warning Broadcast

When an emergency warning broadcast function has been assigned to a function key, the 2 indicators to the left of the key indicate its selection and broadcast statuses. Meanwhile, when the Emergency key is assigned this function, the key indicate its broadcast statuses.



**Note**

For instructions on assigning functions to function keys, see the separate Setting Software Instructions, "EVENT SETTINGS."

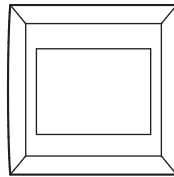
**[When assigned to the Emergency key]**





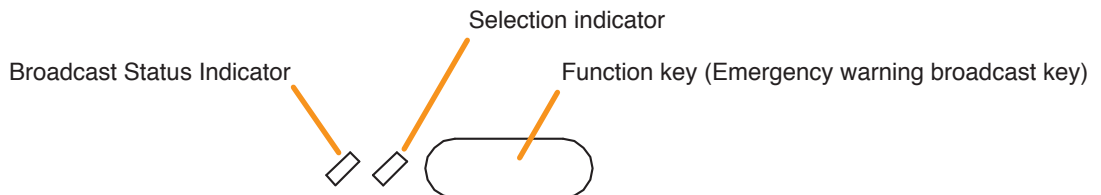

Emergency key

Indicator	Status	Meaning
Emergency Key Indicator	Unlit 	When the audio source for an emergency warning broadcast assigned to the Emergency key is not broadcast to any zones
	Lights red 	When the audio source for an emergency warning broadcast assigned to the Emergency key is broadcast to at least a part of the zones assigned to this key

**[When assigned to the function key]**



The meanings of the 2 indicators next to the Function key are as follows:

Indicator	Status	Meaning
Selection Indicator	Unlit 	When the function key is not pressed
	Lights green 	When the function key is pressed (as long as it is pressed)
Broadcast Status Indicator	Unlit 	When the audio source for an emergency warning broadcast assigned to the function key is not broadcast to any zones
	Lights green 	When the audio source for an emergency warning broadcast assigned to the function key is broadcast to the zones other than those assigned to this key
	Lights yellow 	When the audio source for an emergency warning broadcast assigned to the function key is broadcast to at least a part of the zones assigned to this key



## 2. RM-300X REMOTE MICROPHONE AND RM-210F REMOTE MICROPHONE EXTENSION

### 2.1. Indicator State at the Time of Zone Selection







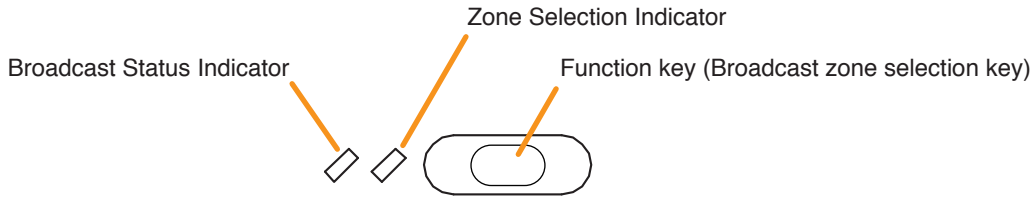

When a zone selection (pattern or individual) function has been assigned to a function key, the 2 indicators to the left of the key indicate its zone selection and broadcast status.

**Note**

For instructions on assigning functions to function keys, see the separate Setting Software Instructions, "EVENT SETTINGS."







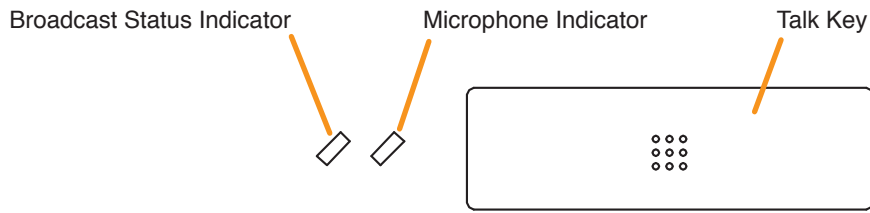

Indicator meanings are as follows:

Indicator	Status	Meaning
Zone Selection Indicator	Unlit 	No zone selected
	Lights green 	Zone selected
Broadcast Status Indicator	Unlit 	Zones assigned to this Broadcast Zone Selection key not in use or BGM broadcast in progress
	Flashes green 	A part of zones or the entire zone assigned to this Broadcast Zone Selection key is occupied by a broadcast from another device (secondary Remote Microphone or general EV message), or a part of zones is engaged by a broadcast from the primary Remote Microphone (RM-300X).
	Lights yellow 	All the zones selected by this Broadcast Zone Selection key on the primary Remote Microphone are engaged by a broadcast from the primary Remote Microphone.
	Flashes yellow 	All the zones assigned to this Broadcast Zone Selection key are engaged by a broadcast from the Secondary Emergency Remote Microphone.
	Lights red 	All the zones assigned to this Broadcast Zone Selection key are engaged by an evacuation message.
	Flashes red 	All the zones assigned to this Broadcast Zone Selection key are engaged by an alert message.
	Lights green 	All the zones assigned to this Broadcast Zone Selection key are engaged by a restoration message.

## 2.2. Talk Key Indicators



The meanings of the 2 indicators next to the Talk key are as follows:

Indicator	Status	Meaning
Microphone Indicator	Unlit 	Microphone not in use
	Lights green 	Microphone in use
	Flashes green 	Chime broadcast in progress from the primary Remote Microphone.
Broadcast Status Indicator	Unlit 	Zone not in use (microphone announcement possible)
	Flashes green 	A part of zones or the entire zone selected by the primary Remote Microphone is occupied by a broadcast from another device (secondary Remote Microphone, chime, etc.), or a broadcast from the primary Remote Microphone is in progress in a part of the zones selected by the primary Remote Microphone.
	Lights yellow 	All zones selected by the primary Remote Microphone are engaged by a broadcast from the primary Remote Microphone.

## 2.3. Indicator State at the Time of Base Pattern Change



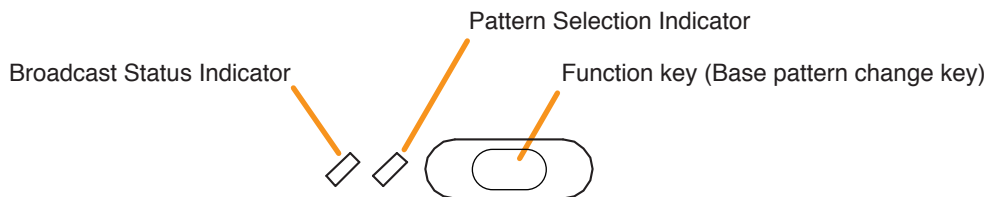

When a Base pattern change function has been assigned to a function key, the 2 indicators to the left of the key indicate its pattern selection and broadcast status.

**Note**

For instructions on assigning functions to function keys, see the separate Setting Software Instructions, "EVENT SETTINGS."



The meanings of the 2 indicators next to the Function key are as follows:

Indicator	Status	Meaning
Pattern Selection Indicator	Unlit 	When the function key is not pressed
	Lights green 	When the function key is pressed (Lights briefly, then goes off)
Broadcast Status Indicator	Unlit 	When the Base pattern assigned to the function key is not being broadcast
	Lights yellow 	When the Base pattern assigned to the function key is being broadcast (including broadcasts activated by other devices)

## 2.4. Indicator State at the Time of General-Purpose Broadcast Pattern



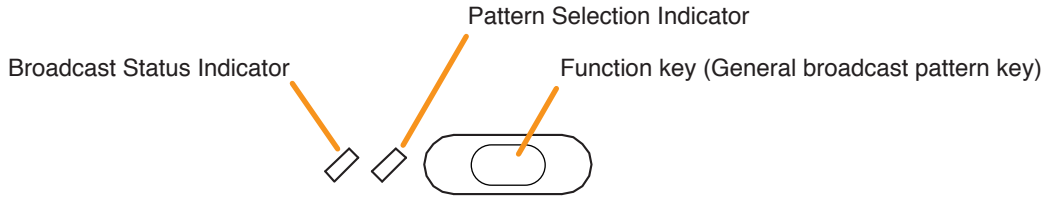

When a general-purpose broadcast pattern function has been assigned to a function key, the 2 indicators to the left of the key indicate its pattern selection and broadcast status.

**Note**

For instructions on assigning functions to function keys, see the separate Setting Software Instructions, "EVENT SETTINGS."



The meanings of the 2 indicators next to the Function key are as follows:

Indicator	Status	Meaning
Pattern Selection Indicator	Unlit 	When the function key is not pressed
	Lights green 	When the function key is pressed
Broadcast Status Indicator	Unlit 	When the broadcast pattern assigned to the function key is not being broadcast
	Flashes yellow 	When the broadcast pattern assigned to the function key is being broadcast

## 2.5. Indicator State at the Time of General/BGM Broadcast



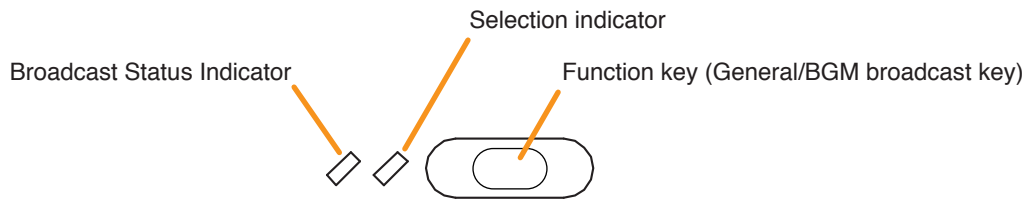

When a general/BGM broadcast function has been assigned to a function key, the 2 indicators to the left of the key indicate its selection and broadcast statuses.

**Note**

For instructions on assigning functions to function keys, see the separate Setting Software Instructions, "EVENT SETTINGS."



The meanings of the 2 indicators next to the Function key are as follows:

Indicator	Status	Meaning
Selection Indicator	Unlit 	When the function key is not pressed
	Lights green 	When the unit is brought in general/BGM broadcast by pressing the function key
Broadcast Status Indicator	Unlit 	When a general/BGM broadcast assigned to the function key is not activated
	Lights green 	When a general/BGM broadcast assigned to the function key is being broadcast from the equipment other than the Remote Microphone
	Lights yellow 	When a general/BGM broadcast assigned to the function key is being broadcast from the primary Remote Microphone or other Remote Microphone

## 2.6. Indicator State at the Time of RM Broadcast Status Display



The Broadcast status indicator to the left of the Function key indicates the current broadcast status of other Remote Microphone.

**Note**

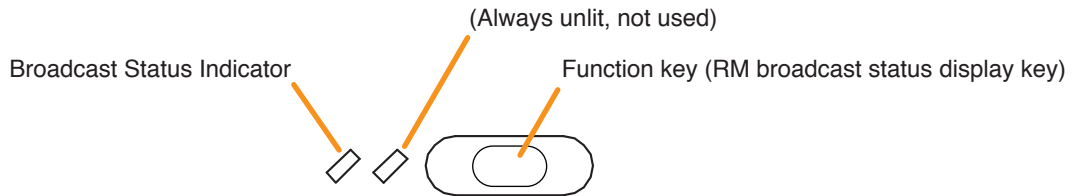
For instructions on assigning functions to function keys, see the separate Setting Software Instructions, "EVENT SETTINGS."



The meanings of the 2 indicators next to the Function key are as follows:

Indicator	Status	Meaning
Broadcast Status Indicator	Unlit 	When the Remote Microphone assigned to the function key is not engaged in broadcasting
	Lights yellow 	When the Remote Microphone assigned to the function key is engaged in broadcasting

## 2.7. Indicator State at the Time of Lamp Test

When the lamp test function has been assigned to the Function key, the 2 indicators to the left of the key indicate the running status of the lamp test.



Pressing the Lamp Test key causes all indicators on the primary Remote Microphone to light, and the built-in buzzer to sound.

**Notes**

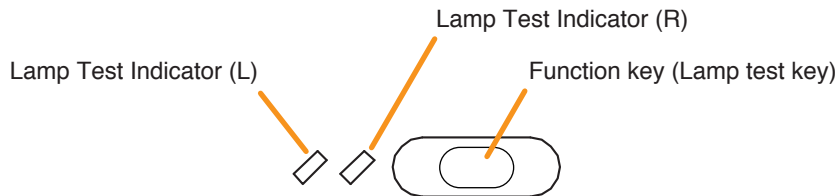
- For instructions on setting the surveillance function, see the separate Setting Software Instructions, "BASIC SETTINGS."
- For the type of the RM-300X settings, see the separate Setting Software Instructions, "Unit Configuration Settings."
- For instructions on assigning functions to function keys, see the separate Setting Software Instructions, "EVENT SETTINGS."



The meanings of the 2 indicators next to the Function key are as follows:

Indicator	Status	Meaning
Lamp Test Indicator	Unlit 	When the function key is not pressed
	Lights yellow and green 	Lamp test has been executed by pressing the function key.

## 2.8. Indicator State at the Time of Failure Output Receipt

When the VX-3000 system is set to enable "Surveillance function," the failure output receipt function can be assigned to a function key.



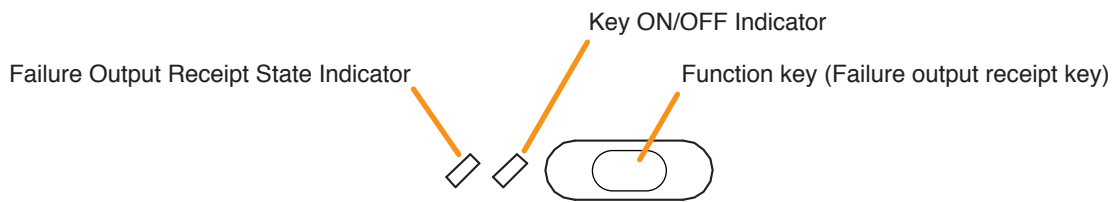

When the failure output receipt function has been assigned to the Function key, the 2 indicators to the left of the key indicate the occurrence and failure output receipt status of the failure output pattern.

### Notes

- For instructions on setting the surveillance function, see the separate Setting Software Instructions, "BASIC SETTINGS."
- For instructions on assigning functions to function keys, see the separate Setting Software Instructions, "EVENT SETTINGS."



The meanings of the 2 indicators next to the Function key are as follows:

Indicator	Status	Meaning
Key ON/OFF Indicator	Unlit 	When the function key is not pressed
	Lights green 	When the function key is pressed (as long as it is pressed)
Failure Output Receipt State Indicator	Flashes yellow 	When the failure output pattern assigned to the function key has occurred
	Lights yellow 	Failure output pattern has been acknowledged after pressing the function key.

## 2.9. Indicator State at the Time of Failure Output Reset

When the VX-3000 system is set to enable "Surveillance function," the failure output reset function can be assigned to a function key.



When the failure output reset function has been assigned to the Function key, the failure status indicator can be reset by pressing the key. The indicator to the left of the key lights only when the key is pressed.

### Notes

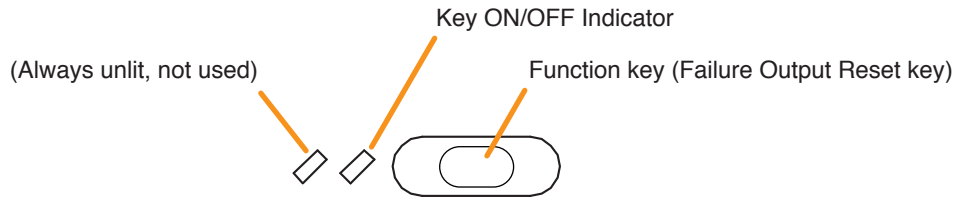
- For instructions on setting the surveillance function, see the separate Setting Software Instructions, "BASIC SETTINGS."
- For instructions on assigning functions to function keys, see the separate Setting Software Instructions, "EVENT SETTINGS."



The meanings of the 2 indicators next to the Function key are as follows:

Indicator	Status	Meaning
Key ON/OFF Indicator	Unlit 	When the function key is not pressed
	Lights green 	When the function key is pressed (as long as it is pressed)

## 2.10. Indicator State at the Time of Emergency Broadcast Pattern Start

When the system is set to "Emergency" and the type of the RM-300X to "Emergency" or "Emergency/General," the emergency broadcast pattern start function can be assigned to the covered key or Function key. Pressing the function-assigned key causes the emergency to start.

When the covered key is assigned this function, the Emergency Indicator next to the key indicates the emergency condition of the VX-3000 system.

Meanwhile, when a function key is assigned this function, the 2 indicators next to the key indicate the emergency start and emergency states of the VX-3000 system.



### Notes

- For the emergency function settings, see the separate Setting Software Instructions, "BASIC SETTINGS."
- For the type of the RM-300X settings, see the separate Setting Software Instructions, "Unit Configuration Settings."
- For instructions on assigning functions to the covered key and function keys, see the separate Setting Software Instructions, "EVENT SETTINGS."

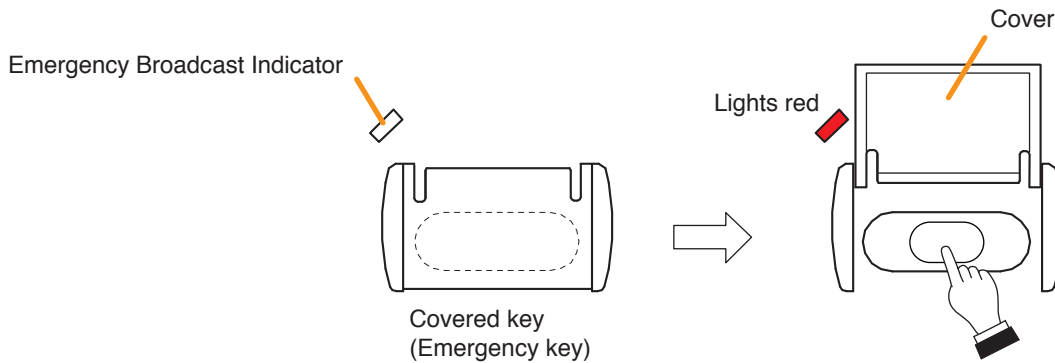
#### [When assigned to the covered key]









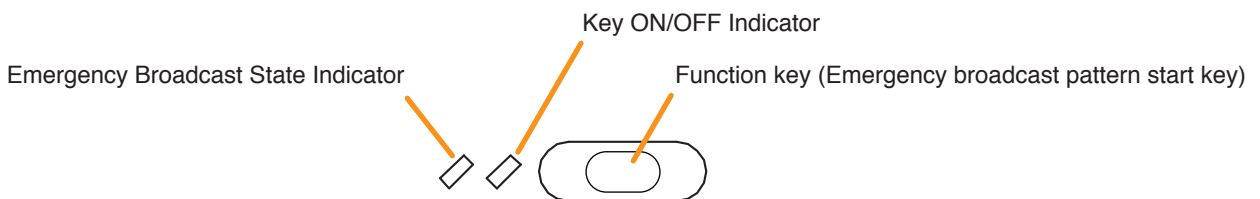

The meanings of the indicator next to the covered key is as follows:

Indicator	Status	Meaning
Emergency Broadcast Indicator	Unlit 	The VX-3000 system is not in an emergency condition.
	Lights red 	The Emergency Broadcast Pattern is started by pressing this Emergency key or the VX-3000 system is in an emergency condition.

#### [When assigned to the function key]



The meanings of the 2 indicators next to the Function key are as follows:

Indicator	Status	Meaning
Key ON/OFF Indicator	Unlit  	When the function key is not pressed
	Lights green  	When the function key is pressed (as long as it is pressed)
Emergency Broadcast State Indicator	Unlit  	Emergency Broadcast Patterns assigned to the function key are not broadcast.
	Flashes red 	A part of Emergency Broadcast Patterns assigned to the function key is broadcast.
	Lights red  	All Emergency Broadcast Patterns assigned to the function key are broadcast.

### 2.11. Indicator State at the Time of Emergency Broadcast Pattern Stop



When the system is set to "Emergency" and the type of the RM-300X to "Emergency" or "Emergency/General," the emergency broadcast pattern stop function can be assigned to the Function key. Pressing the function-assigned key causes the emergency broadcast pattern to stop. The indicator to the left of the key lights only when the key is pressed.

**Notes**

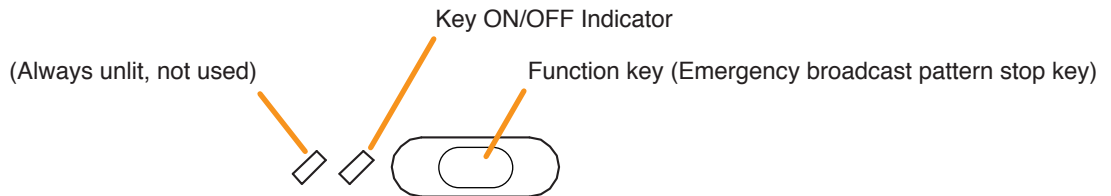
- For the emergency function settings, see the separate Setting Software Instructions, "BASIC SETTINGS."
- For the type of the RM-300X settings, see the separate Setting Software Instructions, "Unit Configuration Settings."
- For instructions on assigning functions to the function keys, see the separate Setting Software Instructions, "EVENT SETTINGS."



The meanings of the 2 indicators next to the Function key are as follows:

Indicator	Status	Meaning
Key ON/OFF Indicator	Unlit 	When the function key is not pressed
	Lights green 	When the function key is pressed (as long as it is pressed)



## 2.12. Indicator State at the Time of Emergency Broadcast Pattern Start/Stop

When the system is set to "Emergency" and the type of the RM-300X to "Emergency" or "Emergency/General," the emergency broadcast pattern start/stop function can be assigned to the covered key or Function key. When the Emergency Broadcast Pattern set to the function-assigned key is OFF, pressing this key activates the emergency broadcast.

When the Emergency Broadcast Pattern set to the function-assigned key is ON, pressing this key stops the corresponding emergency broadcast pattern or returns the emergency mode to the normal state. The selection of which operation to perform depends on the setting.

When the covered key is assigned this function, the Emergency Indicator next to the key indicates the emergency condition of the VX-3000 system.

Meanwhile, when a function key is assigned this function, the 2 indicators next to the key indicate the emergency start and emergency states of the VX-3000 system.



### Notes

- For the emergency function settings, see the separate Setting Software Instructions, "BASIC SETTINGS."
- For the type of the RM-300X settings, see the separate Setting Software Instructions, "Unit Configuration Settings."
- For instructions on assigning functions to the covered key and function keys, see the separate Setting Software Instructions, "EVENT SETTINGS."

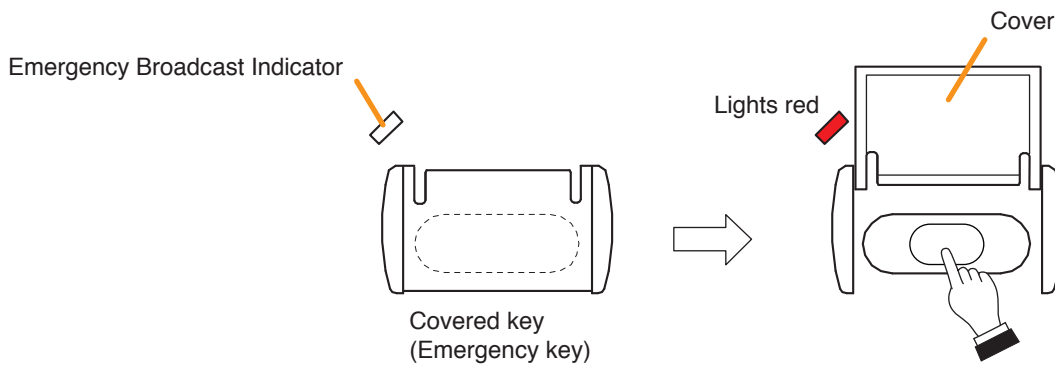
### [When assigned to the covered key]





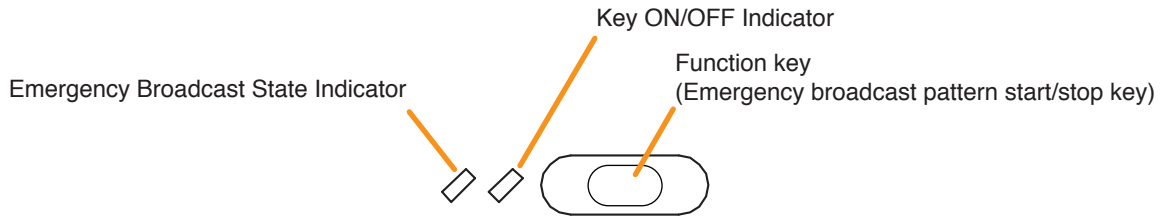

The meanings of the indicator next to the covered key is as follows:

Indicator	Status	Meaning
Emergency Broadcast Indicator	Unlit 	The VX-3000 system is not in an emergency condition.
	Lights red 	The Emergency Broadcast Pattern is started by pressing this Emergency key or the VX-3000 system is in an emergency condition.

[When assigned to the function key]



The meanings of the 2 indicators next to the Function key are as follows:

Indicator	Status	Meaning
Key ON/OFF Indicator	Unlit 	When the function key is not pressed
	Lights green 	When the function key is pressed (as long as it is pressed)
Emergency Broadcast State Indicator	Unlit 	Emergency Broadcast Pattern assigned to the function key is not broadcast.
	Lights green 	Restoration Message broadcast assigned to the function key is being activated.
	Lights red 	Emergency Broadcast Pattern assigned to the function key is broadcast.

2.13. Indicator State at the Time of Emergency Sequence Stop



When the system is set to "Emergency" and the type of the RM-300X to "Emergency" or "Emergency/General," the emergency sequence stop function can be assigned to the Function key. Pressing the function-assigned key causes the emergency sequence to stop. The indicator to the left of the key lights only when the key is pressed.

Notes

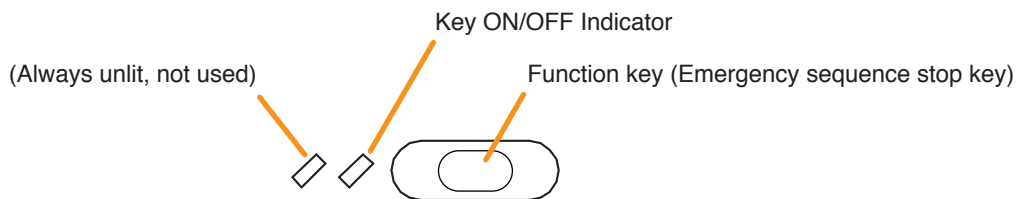
- For the emergency function settings, see the separate Setting Software Instructions, "BASIC SETTINGS."
- For the type of the RM-300X settings, see the separate Setting Software Instructions, "Unit Configuration Settings."
- For instructions on assigning functions to the function keys, see the separate Setting Software Instructions, "EVENT SETTINGS."



The meanings of the 2 indicators next to the Function key are as follows:

Indicator	Status	Meaning
Key ON/OFF Indicator	Unlit 	When the function key is not pressed
	Lights green 	When the function key is pressed (as long as it is pressed)

### 2.14. Indicator State at the Time of Emergency Sequence Phase Shift



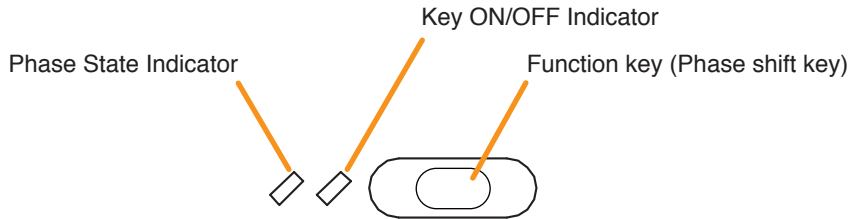

When the system is set to "Emergency" and the type of the RM-300X to "Emergency" or "Emergency/General," the emergency sequence phase shift function can be assigned to a function key. Assigning this function to the Function key causes the 2 indicators next to the Function key to indicate the emergency sequence phase state.

**Notes**

- For the emergency function settings, see the separate Setting Software Instructions, "BASIC SETTINGS."
- For the type of the RM-300X settings, see the separate Setting Software Instructions, "Unit Configuration Settings."
- For instructions on assigning functions to function keys, see the separate Setting Software Instructions, "EVENT SETTINGS."



The meanings of the 2 indicators next to the Function key are as follows:

Indicator	Status	Meaning
Key ON/OFF Indicator	Unlit 	When the function key is not pressed
	Lights green 	When the function key is pressed (as long as it is pressed)
Phase State Indicator	Lights green 	Emergency sequence Phase 1 is assigned to the function key.
	Flashes green 	Emergency sequence Phase 2 is assigned to the function key.
	Unlit 	Emergency sequence Phase 3 is assigned to the function key.

### 2.15. Indicator State at the Time of Emergency Reset



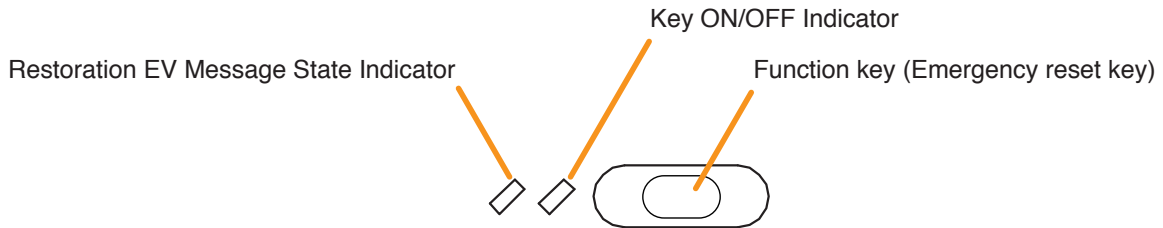

When the system is set to "Emergency" and the type of the RM-300X to "Emergency" or "Emergency/General," the emergency reset function can be assigned to a function key. Assigning this function to the Function key causes the 2 indicators next to the Function key to indicate the emergency reset state.

**Notes**

- For the emergency function settings, see the separate Setting Software Instructions, "BASIC SETTINGS."
- For the type of the RM-300X settings, see the separate Setting Software Instructions, "Unit Configuration Settings."
- For instructions on assigning functions to function keys, see the separate Setting Software Instructions, "EVENT SETTINGS."



The meanings of the 2 indicators next to the Function key are as follows:

Indicator	Status	Meaning
Key ON/OFF Indicator	Unlit 	When the function key is not pressed
	Lights green 	When the function key is pressed (as long as it is pressed)
Restoration EV Message State Indicator	Unlit 	Restoration Message broadcast assigned to the function key is being stopped.
	Lights green 	Restoration Message broadcast assigned to the function key is being activated.

### 2.16. Indicator State at the Time of Audio Monitor





When an audio monitor function has been assigned to a function key, the 2 indicators to the left of the key indicate its selection and audio monitor statuses.

**Note**

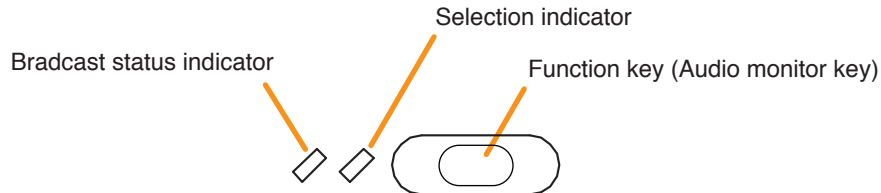
Only one remote microphone can be used for audio monitoring even when 2 or more remote microphones are connected to a single VX-3000F.

Only the remote microphone of which Audio monitor key is pressed most recently is effective for audio monitoring, causing other remote microphone engaged in monitoring to be interrupted.



Indicator	Status	Meaning
Selection indicator	Unlit 	When the function key is not pressed
	Lights green 	When the function key is pressed
Broadcast status indicator	Unlit 	When no broadcast is made to the zone assigned to this function key
	Lights green 	When audio signals are broadcast to the zone assigned to this function key while the function key is held down

### 2.17. Indicator State at the Time of Intended Control Input

When an intended control input function has been assigned to a function key, the 2 indicators to the left of the key indicate its selection and control statuses.





**Note**

Operation may become invalid even if you press the function key when the Control status indicator is lighting. This is such a case when the control input is placed in Active state by other device.

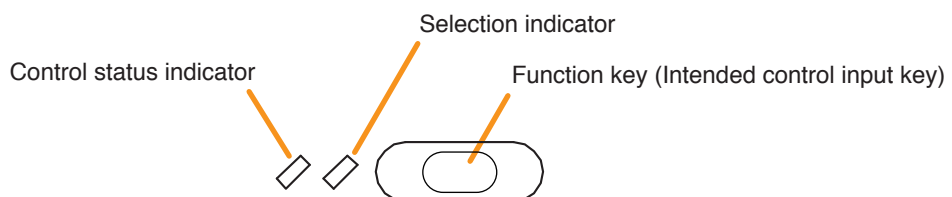
Wait until the Control status indicator goes off, then press the function key again.

Function key operation is always active as long as the Control status indicator is unlit.



Indicator	Status	Meaning
Selection indicator	Unlit 	When the function key is not pressed
	Lights green 	When the function key is pressed
Control status indicator	Unlit 	When the control input assigned to this function key is in Inactive* state
	Lights yellow 	When the control input assigned to this function key is in Active* state

\* When the control input polarity is set to "NO" in the Event setting, the function key becomes Active while the control input is closed, and becomes Inactive when it is open.

Conversely, when the polarity is set to "NC," the function key becomes Active while the control input is open, and becomes Inactive when it is closed.





### 2.18. Indicator State at the Time of Intended Control Output (Pulse)

When the intended control output (pulse) function is assigned to the function key, pressing this key turns ON the preset control output. It is turned OFF when this key is pressed again. When an intended control output (pulse) function has been assigned to a function key, the 2 indicators to the left of the key indicate its selection and control statuses.

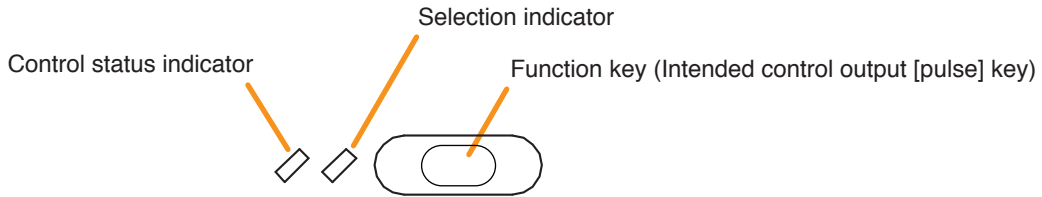
**Note**

Operation may become invalid even if you press the function key when the Control status indicator is lighting. This is such a case when the Control output pattern is being activated by other Event. Wait until the Control status indicator goes off, then press the function key again. Function key operation is always active as long as the Control status indicator is unlit.



Indicator	Status	Meaning
Selection indicator	Unlit 	When the function key is not pressed
	Lights green 	When the function key is pressed
Control status indicator	Unlit 	When the Control output pattern assigned to this function key is not activated
	Lights yellow 	When the Control output pattern assigned to this function key is being activated





### 2.19. Indicator State at the Time of Intended Control Output (Level)

When the intended control output (level) function is assigned to the function key, the preset control output is turned ON while this key is held down. It is turned OFF when this key is released. When an intended control output (level) function has been assigned to a function key, the 2 indicators to the left of the key indicate its selection and control statuses.

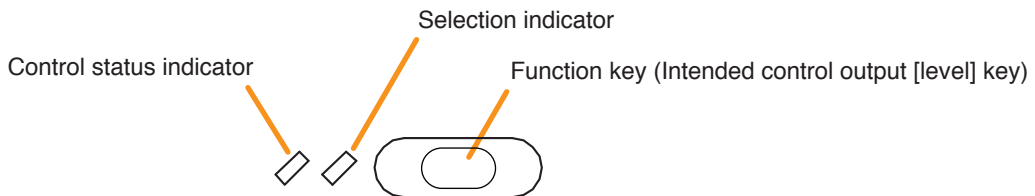
**Note**

Operation may become invalid even if you press the function key when the Control status indicator is lighting. This is such a case when the Control output pattern is being activated by other Event. Wait until the Control status indicator goes off, then press the function key again. Function key operation is always active as long as the Control status indicator is unlit.



Indicator	Status	Meaning
Selection indicator	Unlit 	When the function key is not pressed
	Lights green 	When the function key is pressed (as long as it is pressed)
Control status indicator	Unlit 	When the Control output pattern assigned to this function key is not activated
	Lights yellow 	When the Control output pattern assigned to this function key is being activated

## 2.20. Indicator State at the Time of Zone Volume Adjustment (Pulse)



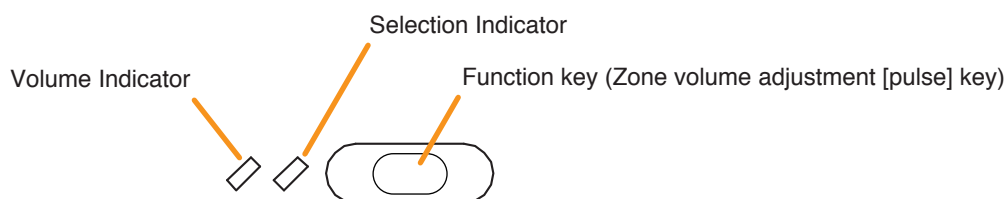

When the Zone volume adjustment (Pulse) function is assigned to the function key, pressing this key increases or decreases the volume level of the preset zone by the set amount. Sound adjustment status can be checked by the indicators to the left of the function key.

### Note

For instructions on assigning functions to function keys, see the separate Setting Software Instructions, "EVENT SETTINGS."



The meanings of the 2 indicators next to the Function key are as follows:

Indicator	Status	Meaning
Selection indicator	Unlit 	When the function key is not pressed
	Lights green 	When the function key is pressed (as long as it is pressed)
Volume Indicator	Unlit 	In the case the set value* <sup>1</sup> of the volume adjustment is positive (volume increase): When the current volume adjustment value of the zone assigned to this key is less than the initial value* <sup>2</sup>  In the case the set value* <sup>1</sup> of the volume adjustment is negative (volume decrease): When the current volume adjustment value of the zone assigned to this key is greater than the initial value* <sup>2</sup>
	Lights green 	In the case the set value* <sup>1</sup> of the volume adjustment is positive (volume increase): When the current volume adjustment value of the zone assigned to this key is greater than the initial value* <sup>2</sup>  In the case the set value* <sup>1</sup> of the volume adjustment is negative (volume decrease): When the current volume adjustment value of the zone assigned to this key is less than the initial value* <sup>2</sup>

\*<sup>1</sup> Value set in "Event setting" of the VX-3000 Setting Software.

\*<sup>2</sup> Volume set in "Sound settings (output)" of the VX-3000 Setting Software.

### 2.21. Indicator State at the Time of Input Volume Adjustment (Pulse)



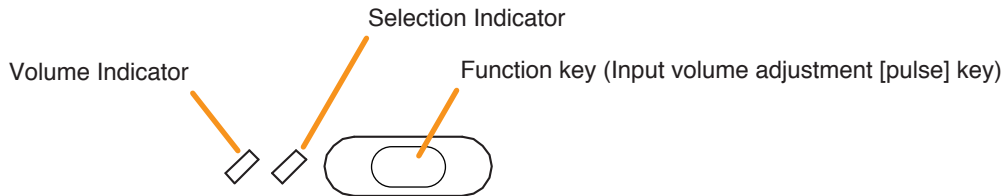

When the Input volume adjustment (Pulse) function is assigned to the function key, pressing this key increases or decreases the volume level of the preset Input channel by the set amount. Sound adjustment status can be checked by the indicators to the left of the function key.

**Note**

For instructions on assigning functions to function keys, see the separate Setting Software Instructions, "EVENT SETTINGS."



The meanings of the 2 indicators next to the Function key are as follows:

Indicator	Status	Meaning
Selection indicator	Unlit 	When the function key is not pressed
	Lights green 	When the function key is pressed (as long as it is pressed)
Volume Indicator	Unlit 	In the case the set value* <sup>1</sup> of the volume adjustment is positive (volume increase): When the current volume adjustment value of the input channel assigned to this key is less than the initial value* <sup>2</sup>  In the case the set value* <sup>1</sup> of the volume adjustment is negative (volume decrease): When the current volume adjustment value of the input channel assigned to this key is greater than the initial value* <sup>2</sup>
	Lights green 	In the case the set value* <sup>1</sup> of the volume adjustment is positive (volume increase): When the current volume adjustment value of the input channel assigned to this key is greater than the initial value* <sup>2</sup>  In the case the set value* <sup>1</sup> of the volume adjustment is negative (volume decrease): When the current volume adjustment value of the input channel assigned to this key is less than the initial value* <sup>2</sup>

\*<sup>1</sup> Value set in "Event setting" of the VX-3000 Setting Software.

\*<sup>2</sup> Volume set in "Sound settings (input)" of the VX-3000 Setting Software.



## 2.22. Indicator State at the Time of Emergency Warning Broadcast

When an emergency warning broadcast function has been assigned to a function key, the 2 indicators to the left of the key indicate its selection and broadcast statuses. Meanwhile, when the Emergency key is assigned this function, the key indicate its broadcast statuses.



**Note**

For instructions on assigning functions to function keys, see the separate Setting Software Instructions, "EVENT SETTINGS."

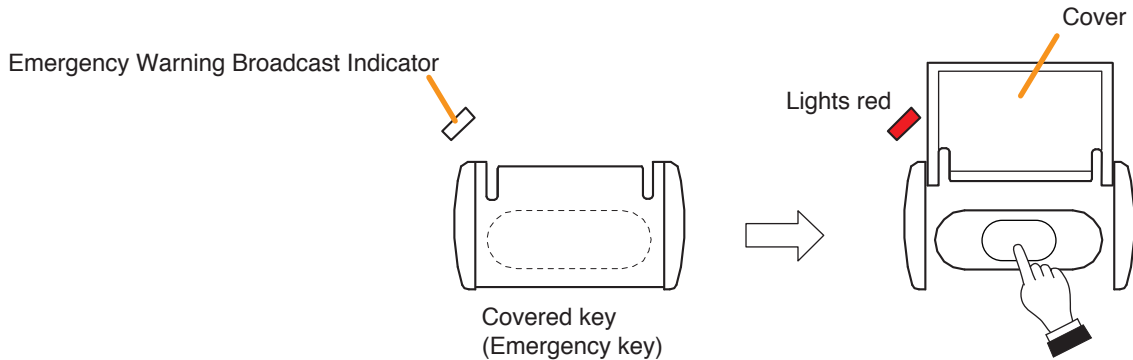
**[When assigned to the covered key]**









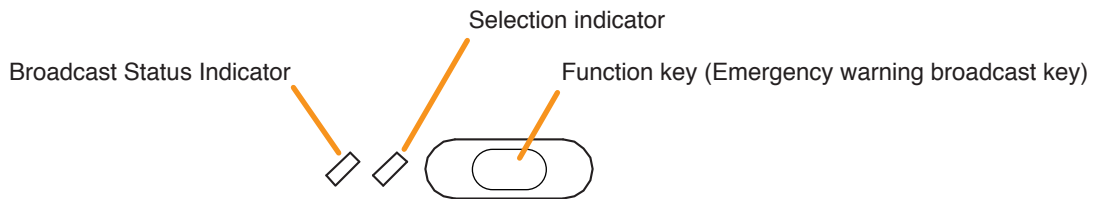



The meanings of the indicator next to the covered key is as follows:

Indicator	Status	Meaning
Emergency Warning Broadcast Indicator	Unlit 	When the audio source for an emergency warning broadcast assigned to the Emergency key is not broadcast to any zones
	Lights red 	When the audio source for an emergency warning broadcast assigned to the Emergency key is broadcast to at least a part of the zones assigned to this key

**[When assigned to the function key]**



The meanings of the 2 indicators next to the Function key are as follows:

Indicator	Status	Meaning
Selection Indicator	Unlit  	When the function key is not pressed
	Lights green  	When the function key is pressed (as long as it is pressed)
Broadcast Status Indicator	Unlit  	When the audio source for an emergency warning broadcast assigned to the function key is not broadcast to any zones
	Lights green  	When the audio source for an emergency warning broadcast assigned to the function key is broadcast to the zones other than those assigned to this key
	Lights yellow  	When the audio source for an emergency warning broadcast assigned to the function key is broadcast to at least a part of the zones assigned to this key

# ***Chapter 3***

---

## ***OPERATION***

## 1. BGM AND GENERAL BROADCAST

### 1.1. Broadcasting from the RM-200SF, RM-300X, RM-320F, and RM-210F

The function keys of the remote microphone can be used to make microphone announcements, to change or end BGM broadcasts, and to activate or end general-purpose and general EV broadcasts.

For instructions on assigning functions to function keys, see the separate Setting Software Instructions, "EVENT SETTINGS."

The example here shows the RM-300X, but the basic operation and displays are the same for the RM-200SF, RM-320F, and RM-210F.

### 1.2. Assignment Example

#### [Setting example to function keys]

Key	Item Name	Function
Function key R1	Zones 1, 2 and 3	Zone selection (pattern)
Function key R2	Zone 1	Zone selection (individual)
Function key R3	Zone 2	Zone selection (individual)
Function key R4	Zone 3	Zone selection (individual)
Function key R5	Zone clear	Clear pre selected zones
Function key R6	General broadcast pattern 1	Activation and end of general broadcast pattern 1 broadcast
Function key R7	General EV broadcast	Activation and end of general/BGM broadcast
Function key R8	Zone 1 volume up	Zone volume adjustment (pulse)
Function key R9	Zone 1 volume down	Zone volume adjustment (pulse)
Function key 11	Input 1 volume up	Input volume adjustment (pulse)
Function key 12	Input 1 volume down	Input volume adjustment (pulse)
Function key L1	BGM pattern 1	Activation of base pattern 1 broadcast
Function key L2	BGM pattern 2	Activation of base pattern 2 broadcast
Function key L3	BGM end	Interrupt base broadcast pattern
Talk key		Lock type, Start Chime: 1, End Chime: None

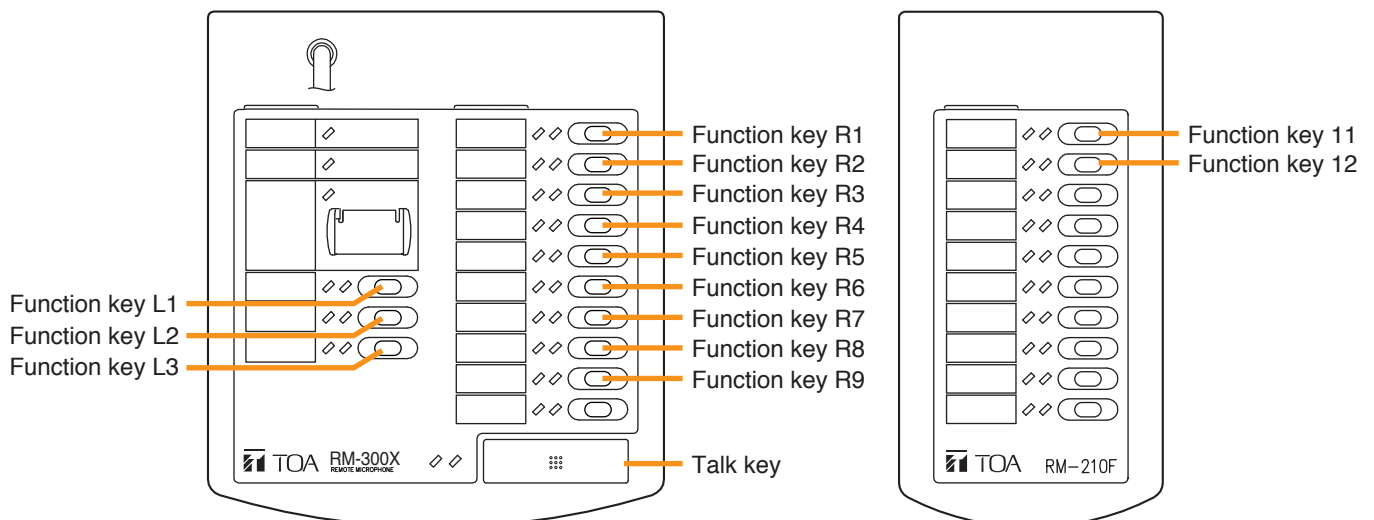

### 1.3. Operation Examples

#### 1.3.1. Example of broadcasting to the selected (pattern-designated) zone

**Step 1.** Press Function key R1 (Zones 1, 2 and 3).  
All of the designated zones are selected, and the zone selection indicator next to Function key R1 lights green.

**Note**  
To cancel the selection, press Function key R1 again, or press Function key R5 (Zone clear).  
The zone selection indicator will go off.

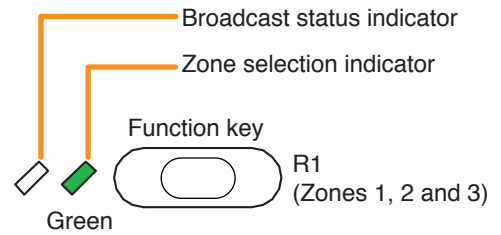

**Step 2.** Press the Talk key.  
A chime will be broadcast. This chime will be audible through the monitor speaker built in the RM-300X.



The Microphone indicator flashes green while the chime is being activated. (RM-300X only)

**Note**  
Pressing the Talk key again while the chime is being activated causes the chime to stop, ending the broadcast in progress.

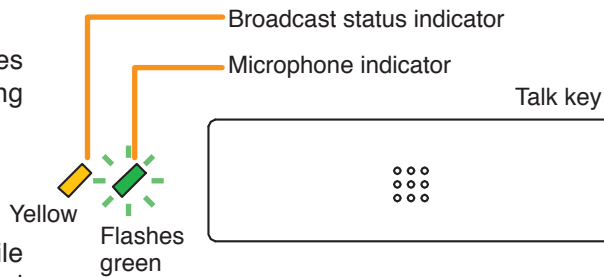

**Step 3.** When the microphone indicator next to the Talk key lights green, make the microphone announcement.  
The zones assigned to Function keys R2 – R4 are included within the zone selection pattern assigned to Function key R1. Therefore, the broadcast status indicators next to Function keys R2 – R4 will light yellow in the same way.

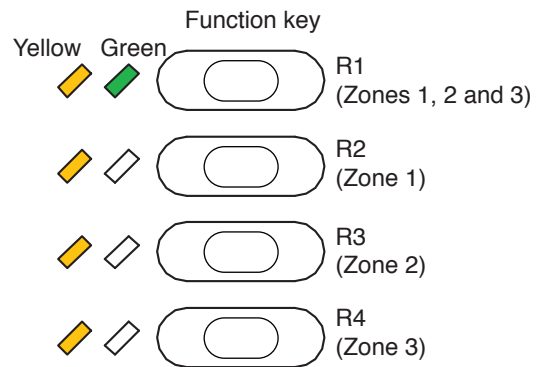

**Step 4.** Press the Talk key.  
The broadcast ends.



**Step 5.** Press Function key R5 (Zone clear).  
The zone selection is cancelled.

**Note**  
If it is desired that the zone selection be left unchanged, there is no need to clear the selected zones.

1.3.2. Example of broadcasting to the selected (individual) zone

**Step 1.** Press Function key R2 (Zone 1) and Function key R3 (Zone 2).  
Zones 1 and 2 are selected, and their zone selection indicators light green.

**Note**

To cancel a selected zone, press the Function key for that zone again. The zone selection indicator for that key will go off.

To cancel all selected zones, press Function key R5 (Zone clear). Both zone selection indicators will go off.

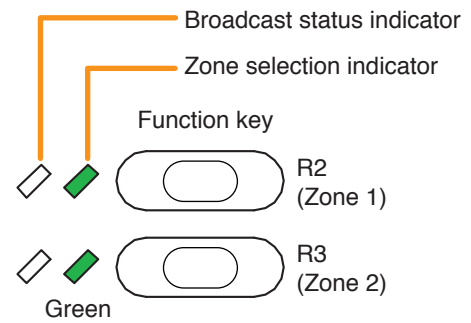

**Step 2.** Press the Talk key.

A chime will be broadcast. This chime will be audible through the monitor speaker built in the RM-300X.

The Microphone indicator flashes green while the chime is being activated. (RM-300X only)

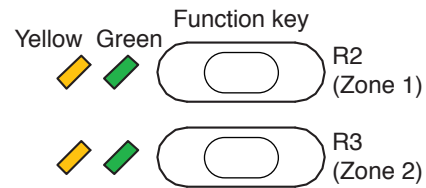

**Note**

Pressing the Talk key again while the chime is being activated causes the chime to stop, ending the broadcast in progress.

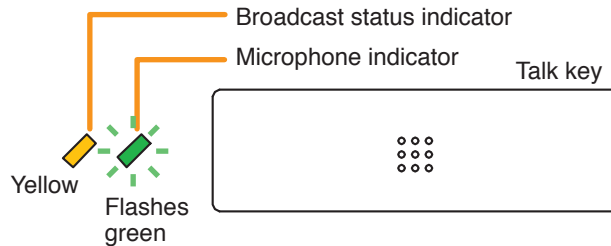

**Step 3.** When the microphone indicator next to the Talk key lights green, make the microphone announcement. Because a portion of the pattern assigned to Function key R1 is included in the selected zones, the broadcast status indicator next to this key will flash green.

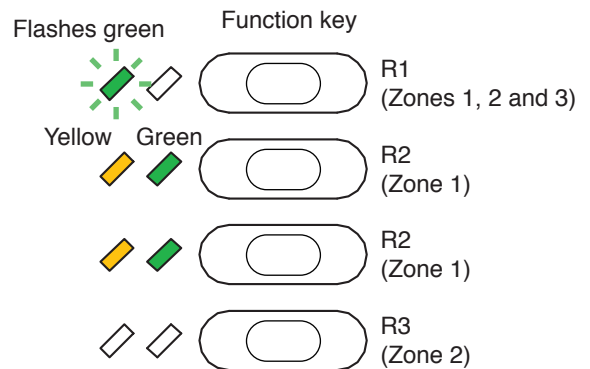

**Step 4.** Press the Talk key.  
The broadcast ends.

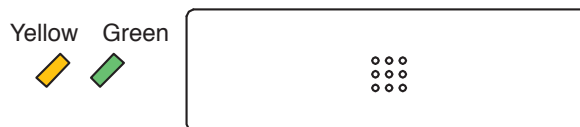

**Step 5.** Press Function key R5 (Zone clear).  
The zone selection is cancelled.

**Note**

If it is desired that the zone selection be left unchanged, there is no need to clear the selected zones.

### 1.3.3. Example of broadcasting to the preset zone

You can make broadcasts from the remote microphone to the preset zones only by pressing the Talk key if you assign the broadcast zone patterns to the Talk key in advance.

**Note**

For instructions on assigning zone pattern to talk key, see the separate Setting Software Instructions, "EVENT SETTINGS."

**Step 1.** Press the Talk key.

A zone preset to the Talk key will be selected, and a chime will be broadcast. This chime will be audible through the monitor speaker built in the RM-300X.

The Microphone indicator flashes green while the chime is being activated. (RM-300X only)

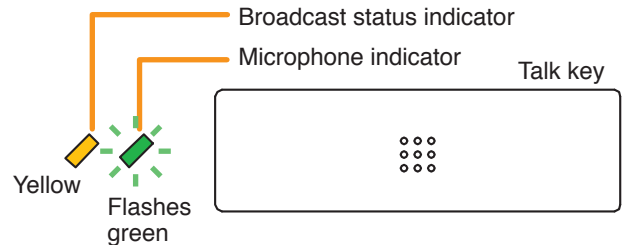

**Note**

Pressing the Talk key again while the chime is being activated causes the chime to stop, ending the broadcast in progress.

**Step 2.** When the microphone indicator next to the Talk key lights green, make the microphone announcement.



**Step 3.** Press the Talk key.

The broadcast ends.

### 1.3.4. Example of BGM broadcasting

Following is the operation example in the case where BGM broadcast is made by the BGM pattern 1 in the morning and changed to the BGM pattern 2 in the afternoon, and then ended.

**Step 1.** Press the Function key L1 (BGM pattern 1).  
 BGM pattern 1 is selected and activated.  
 After the pattern selection indicator next to Function key L1 lights green then goes off, the broadcast status indicator lights yellow.

**Note**  
 To cancel the selection, press Function key L3 (BGM end). The broadcast status indicator will go off.

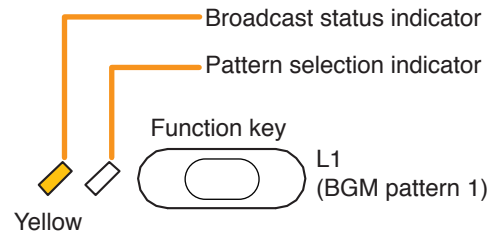

**Step 2.** Press the Function key L2 (BGM pattern 2).  
 BGM pattern 2 is selected, ending BGM pattern 1, and BGM pattern 2 is activated.  
 After the pattern selection indicator next to Function key L2 lights green then goes off, the broadcast status indicator lights yellow.  
 The broadcast status indicator next to Function key L1 goes off.

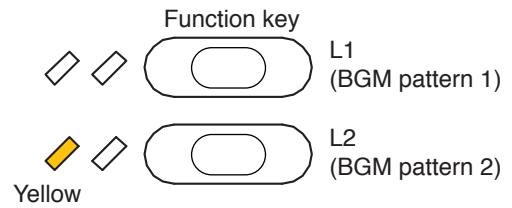

**Step 3.** Press the Function key L3 (BGM end).  
 BGM ends. All indicators go off.

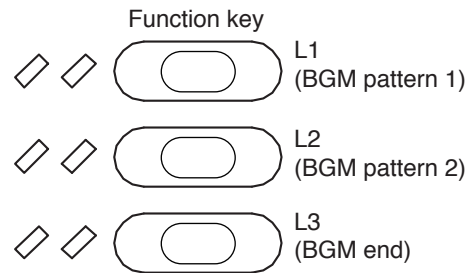

### 1.3.5. Example of general broadcasting

**Step 1.** Press the Function key R6 (General broadcast pattern 1).  
 General broadcast pattern 1 is selected and activated.  
 After the selection indicator next to Function key R6 lights green, the broadcast status indicator flashes yellow.

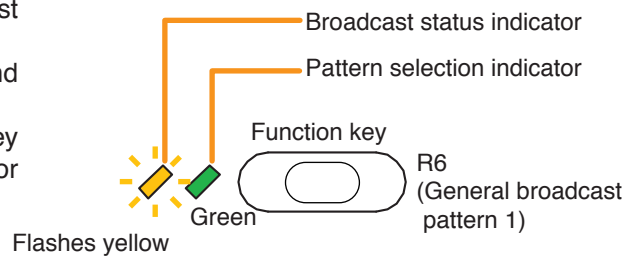

**Step 2.** Press the Function key R6 (General broadcast pattern 1) again.  
 General broadcast pattern 1 being activated stops.  
 The pattern selection indicator and the broadcast status indicator next to Function key R6 go off.

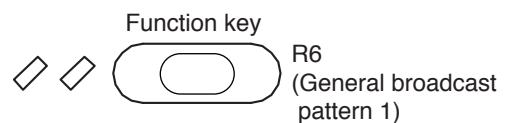

### 1.3.6. Example of general EV broadcasting

Here, an operation example based on the zone patterns is explained.

**Step 1.** Press the function key R1 (Zones 1, 2, and 3).  
All the set zones are selected, and the zone selection indicator of the function key R1 lights green.

**Note**  
To reset selection, press the function key R1 again or the function key R5 (Zone clear).  
The selection indicator goes off.

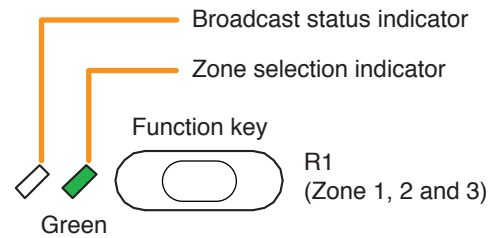

**Step 2.** Press the function key R7 (General EV broadcast).  
General EV message is broadcast to the selected zones.  
The Zone selection indicator of the function key R7 lights green, and the Broadcast status indicator lights yellow.  
Also Broadcast status indicators of the function keys R1, R2, R3, and R4 flash green.

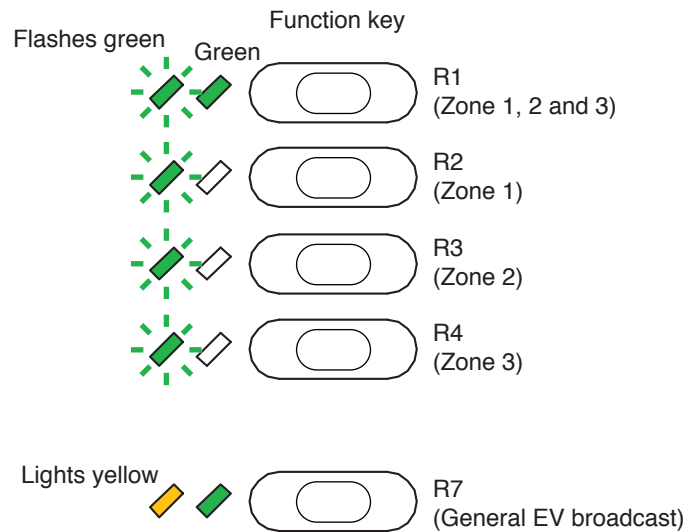

### 1.3.7. Example of zone volume adjustment

[When increasing the volume level of the preset zone]

**Step:** Press the function key R8 (Zone 1 volume up) several times until the volume becomes the desired level.  
Each time the key is pressed, the volume level of the set zone or that of the zone pattern increases by the set amount.  
The volume indicator lights green when the volume level becomes greater than the initial value\* of that zone.

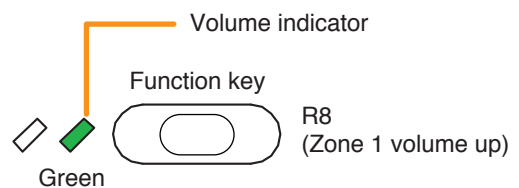

[When decreasing the volume level of the preset zone]

**Step:** Press the function key R9 (Zone 1 volume down) several times until the volume becomes the desired level.  
Each time the key is pressed, the volume level of the set zone or that of the zone pattern decreases by the set amount.  
The volume indicator lights green when the volume level becomes smaller than the initial value\* of that zone.

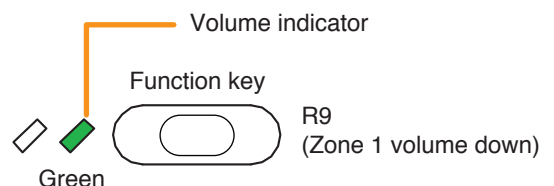

\* Volume set in "Sound settings (output)" of the VX-3000 Setting Software.



### 1.3.8. Example of input volume adjustment

#### [When increasing the volume level of the preset input channel]

**Step:** Press the function key 11 (Input 1 volume up) several times until the volume becomes the desired level.  
 Each time the key is pressed, the volume level of the set input channel increases by the set amount.  
 The volume indicator lights green when the volume level becomes greater than the initial value\* of that input channel.

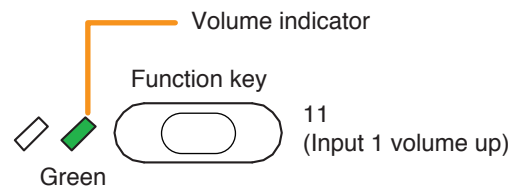

#### [When decreasing the volume level of the preset input channel]

**Step:** Press the function key 12 (Input 1 volume down) several times until the volume becomes the desired level.  
 Each time the key is pressed, the volume level of the set input channel decreases by the set amount.  
 The volume indicator lights green when the volume level becomes smaller than the initial value\* of that input channel.

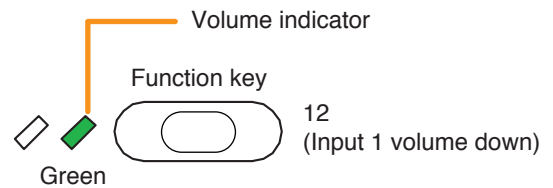

\* Volume set in "Sound settings (input)" of the VX-3000 Setting Software.

## 2. EMERGENCY WARNING BROADCAST

You can start an emergency warning broadcast using the remote microphone's key. The preset audio source applied to the VX-3000F's Audio input can be broadcast to the preset zones while the key is held down.

Emergency warning broadcast can be made even during power failure. When attenuators are used in the broadcast zones, the emergency warning broadcast is made bypassing the attenuators and signal processing. When the priority set to the emergency warning broadcast is higher than the emergency broadcast, the emergency warning broadcast will override the emergency broadcast while left in the emergency mode even during emergency broadcast. During general broadcast, the emergency warning broadcast will override the general broadcast while left in the normal mode.

When the emergency warning broadcast is activated while the higher-priority broadcast is in progress, the emergency warning broadcast is placed in standby, and will start after the higher-priority broadcast is complete.

### [Operation example for the emergency warning broadcast]

The example below shows the operation procedure when the "Emergency warning broadcast" is assigned to the RM-300X's Emergency key.

**Step 1.** Open the cover, then continue to press the Emergency Warning Broadcast key.

The emergency warning broadcast continues and the Emergency warning broadcast indicator lights red while the key is held down.

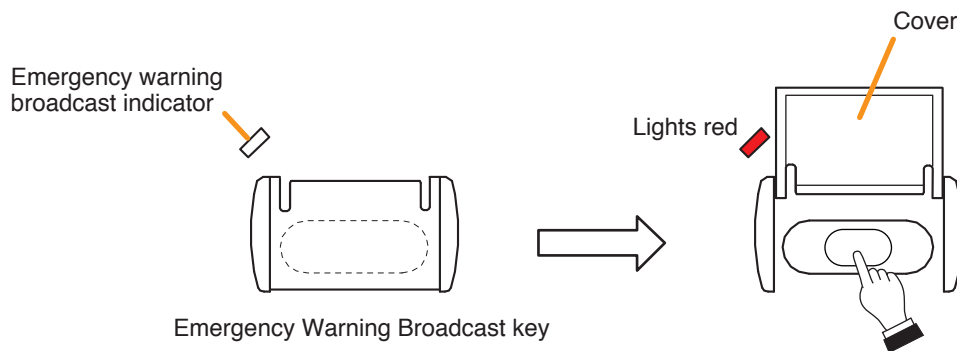

**Step 2.** Release the Emergency Warning Broadcast key, then close the cover.

The emergency warning broadcast is terminated and the Emergency warning broadcast indicator will go out.

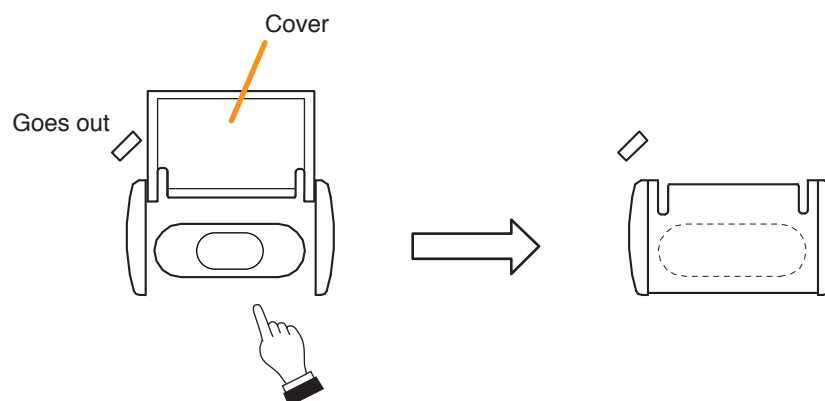

### 3. EMERGENCY BROADCAST

#### 3.1. Typical System Examples

Here, an example of sequential operation with the VX-3000 system is explained.

##### [Sequential Operation]

Sequential operation consists of Phase 1 and Phase 2.

Sequence Phase 1 operates upon emergency system activation. When the set time interval elapses, the broadcast is automatically switched to Phase 2.

##### [Setting Contents]

Both the broadcast messages and output zones are set for Phase 1 and Phase 2.

Assuming that these phases are set as follows:

**Phase 1:** The alert message is continuously broadcast for 5 minutes to each floor of each building.

**Phase 2:** The evacuation message is continuously broadcast to the entire zone.

##### [Alert and Evacuation Message Examples]

**Alert Message:** The fire alarm system has been engaged. We are now checking the cause. Please wait for further information.

**Evacuation Message:** There is a fire. Please evacuate immediately.

**Step 1.** Background music (BGM) is broadcast to A-GF (Building A ground floor) and B-GF (Building B ground floor) when the system is in general-purpose broadcast mode.

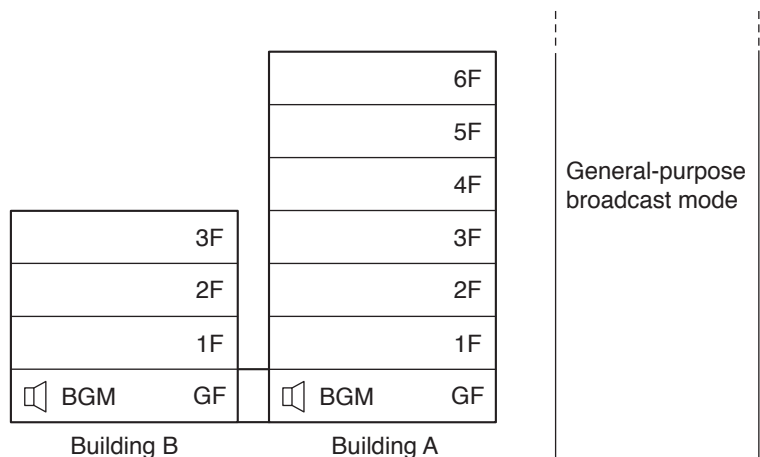

**Step 2.** The sensor installed on A-3F detects irregularities, and the fire alarm system transmits a control signal to the control input. The emergency mode is activated, allowing the alert message to be played through to A-3F.

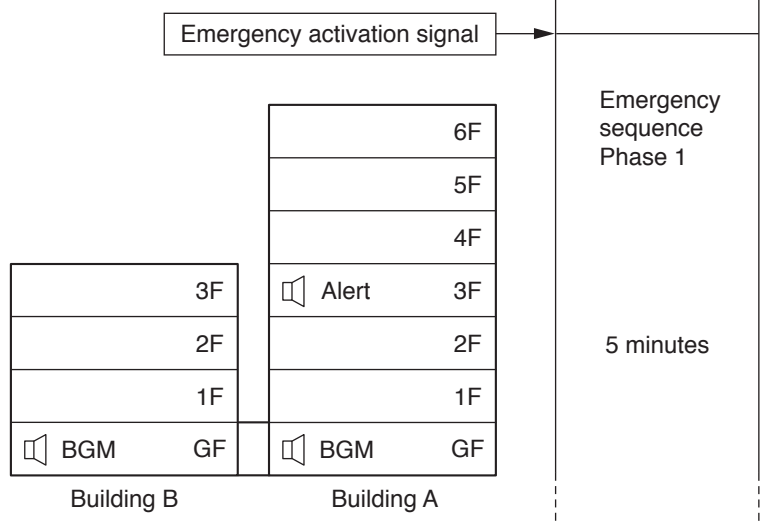

**Step 3.** Following this, the sensors installed on A-2F and A-4F detect irregularities and the fire alarm system transmits a control signal to the control input. Broadcast zones are added, and the alert message is also broadcast to A-2F and A-4F, as well.

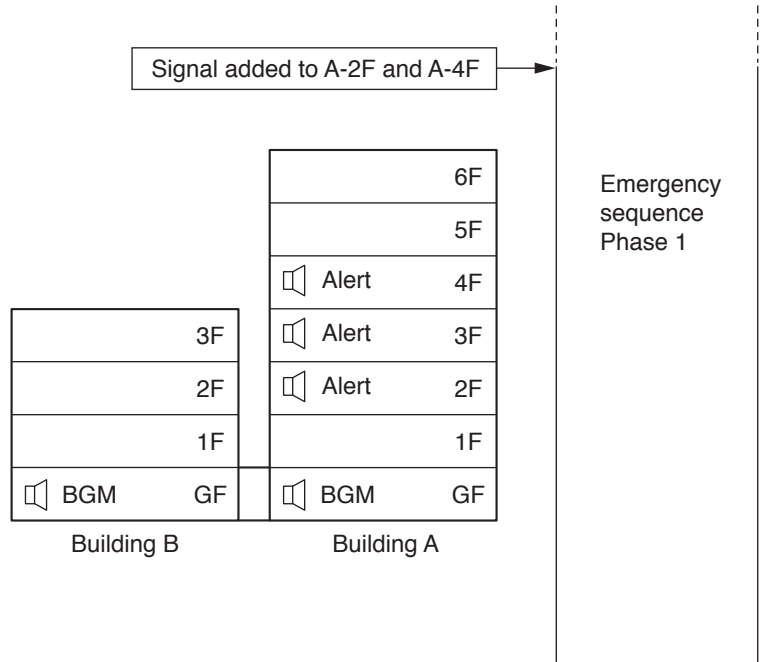

**Step 4.** After the set 5-minute time interval elapses, the message is automatically switched from Phase 1 to Phase 2. Broadcast zones change to the "entire zone" and the evacuation message is broadcast to the entire area, and BGM stops. The evacuation announcement continues until the Remote Microphone's Reset key is pressed or a restoration signal is transmitted from the connected fire alarm system.

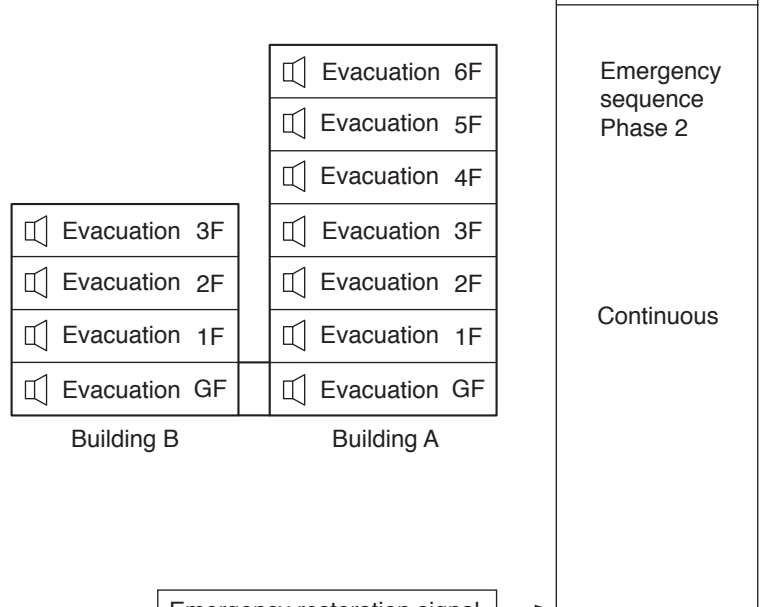

**Step 5.** The fire alarm system transmits a restoration control signal to the control input. The emergency mode is terminated and the broadcast reverts to general-purpose broadcast mode, restoring BGM output.

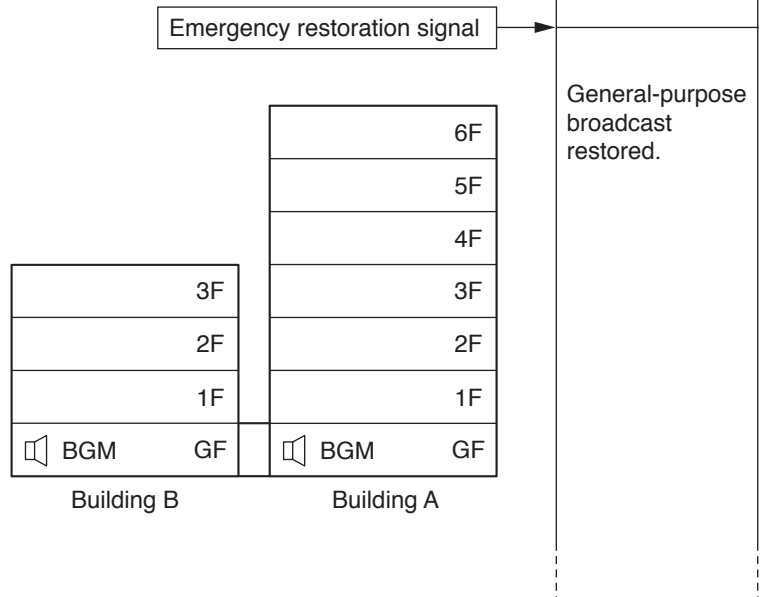

### 3.2. Remote Microphone Operation Example

The emergency mode can not only be activated and restored from the connected fire alarm system, but also from any Remote Microphone set for emergency/general-purpose operation.

Here, the settings of the Fireman's Microphone RM-200SF installed on GF of Building A are used as an example to explain the flow from emergency mode activation to its restoration.

#### [Setting Contents of Fireman's Microphone]

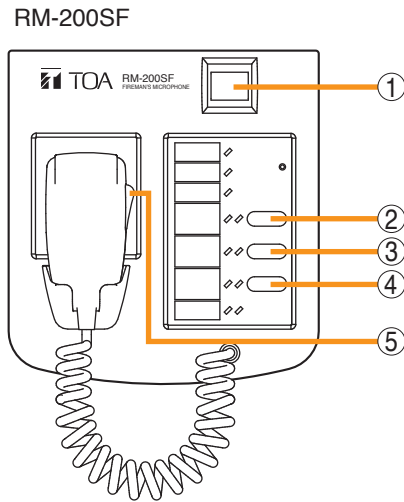

Key	Setting	Function
(1)	Emergency Broadcast Pattern Start	Activates emergency mode and recalls emergency sequence patterns. [Pattern contents] Phase 1: Alert message; all zones; 5 minutes Phase 2: Evacuation message; all zones; continuous
(2)	Emergency Sequence Phase Shift	Shifts the phase of the sequence pattern currently being broadcast to the next phase.
(3)	Emergency Reset (Restoration message)	Broadcast is restored from emergency to normal (general-purpose) broadcast mode after Restoration message announcement completion.
(4)	All-Zone Call	Selects all zones.
(5)	Press-to-Talk	Makes microphone announcements.

For instructions on assigning functions to function keys, see the separate Setting Software Instructions, "EVENT SETTINGS."

**[Operation example]**

Described below are the steps of system operation from emergency mode activation to restoration.

**Step 1.** Press the Emergency key (1).

- Emergency mode is activated and the Emergency key lights red.
- The pre-configured emergency sequence pattern is recalled, and the Alert Message is broadcast to all zones.
- The Zone monitor indicator of the All-Zone Call key (4) indicates the type of message currently being broadcast. It flashes red to indicate that an alert message is currently being broadcast.

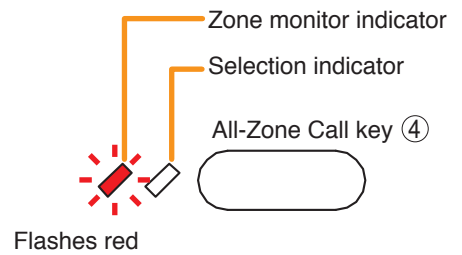
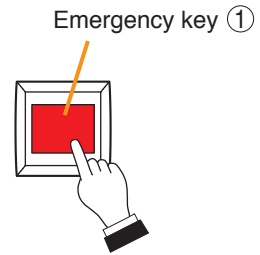

- The Phase state indicator of the Emergency Sequence Phase Shift key (2) lights green when the emergency sequence phase 1 is broadcast.

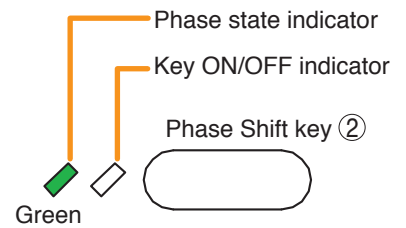

**Step 2.** Press the Emergency Phase Shift key (2) to broadcast the Evacuation message, if necessary. The Evacuation message will be broadcast to all zones. In this event, the broadcast pattern shifts from the emergency sequence phase 1 to the phase 2, and the Phase state indicator flashes green.

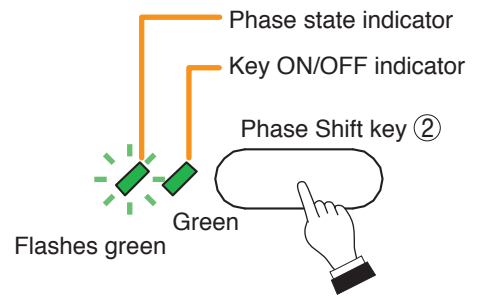

The Zone monitor indicator of the All-Zone Call key (4) indicates the type of message currently being broadcast. It changes from flashing red to steady red status to indicate that the evacuation message is being broadcast.

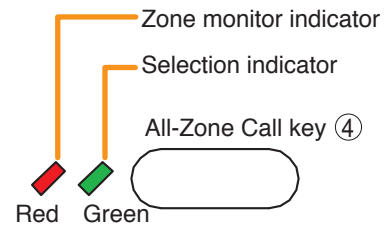

The Emergency Sequence function automatically switches the current message to the Evacuation message after a 5-minute interval if nothing is done.

**Step 3.** When making broadcast using the RM-200SF, follow the procedures below.

- Press the All-Zone Call key (4) to select all zones. In this event, the Selection indicator lights.

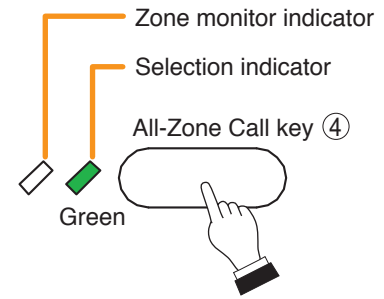

- Press the Talk switch (5), then make voice announcements to all zones. In this event, the Broadcast status indicator lights yellow, and the Microphone indicator lights green.

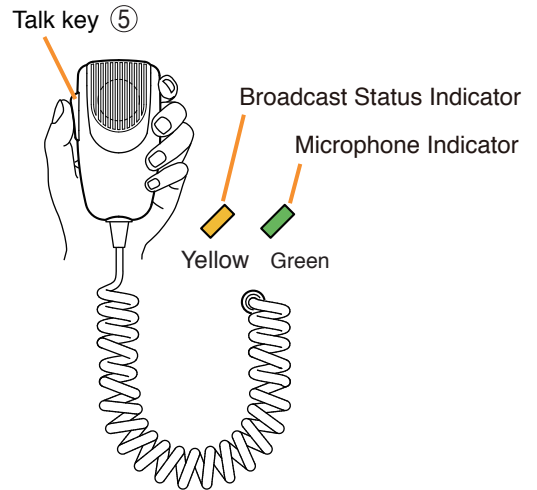

Also, the Zone monitor indicator of the All-Zone Call key (4) lights yellow.

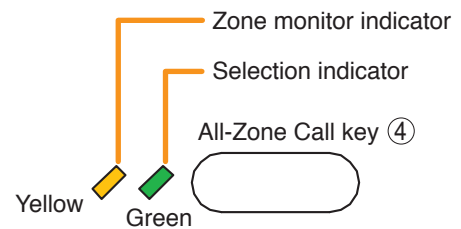

**Tip**

When a Fireman's Microphone announcement interrupts a message broadcast, the broadcast mode that follows Fireman's Microphone announcement completion can be set to either "Continue" for continuous EV message broadcast or "Silent" for broadcast termination. This setting can be made by using the VX-3000 Setting Software.

**Step 4.** Terminate the Emergency status.

Press the Emergency Reset key (3).

The restoration message is broadcast to the entire zone, and the Restoration EV message status indicator of the Emergency Reset key (3) lights while the message is broadcast.

After the message broadcast completion, the VX-3000 system is restored from Emergency status to the General-purpose broadcast status, and the Emergency status indicator (1) built in the Emergency key goes off.

Emergency key (1)

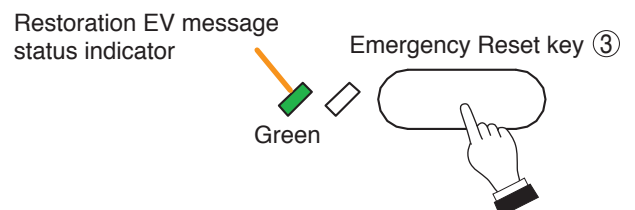
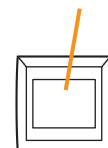

## 4. MAKING ALL-ZONE EMERGENCY BROADCAST

If normal broadcasts cannot be made due to system failure or some trouble, only an all-call is possible.

This is a broadcast made by bypassing the CPU\* that normally operates in the VX-3000 system. (For details, see the separate Installation Manual, "INSTALLATION AND SETTING PROCEDURES.")

This broadcast is called "All-zone emergency broadcast."

All-zone emergency broadcast can be made by operating the DIP switch of the RM-300X or RM-200SF independently of settings performed using the VX-3000 Setting Software. (For operations of the RM-300X, see p. 3-16. For operations of the RM-200SF, see p. 3-17.)

\* CPU is a central processing unit, which is built in the VX-3004F, VX-3008F, and VX-3016F.

### 4.1. Priority Control of the All-Zone Emergency Broadcast

In the All-zone emergency broadcast, how the priority control operates depends on the destination to which the RM-300X or RM-200SF is connected regardless of the priority setting made on the VX-3000 Setting software.

The relationship between the priority order and the connection destination is described below.

When broadcasts with the same priority overlap, they are mixed and output.

Connection destination with the highest priority: RS LINK A terminal of the VX-3000F set to ID "0"

Connection destination with 2nd highest priority: RS LINK B terminal of the VX-3000F set to ID "0"

Connection destination with 3rd highest priority: RS LINK A and B terminals of the VX-3000F set to ID other than "0"

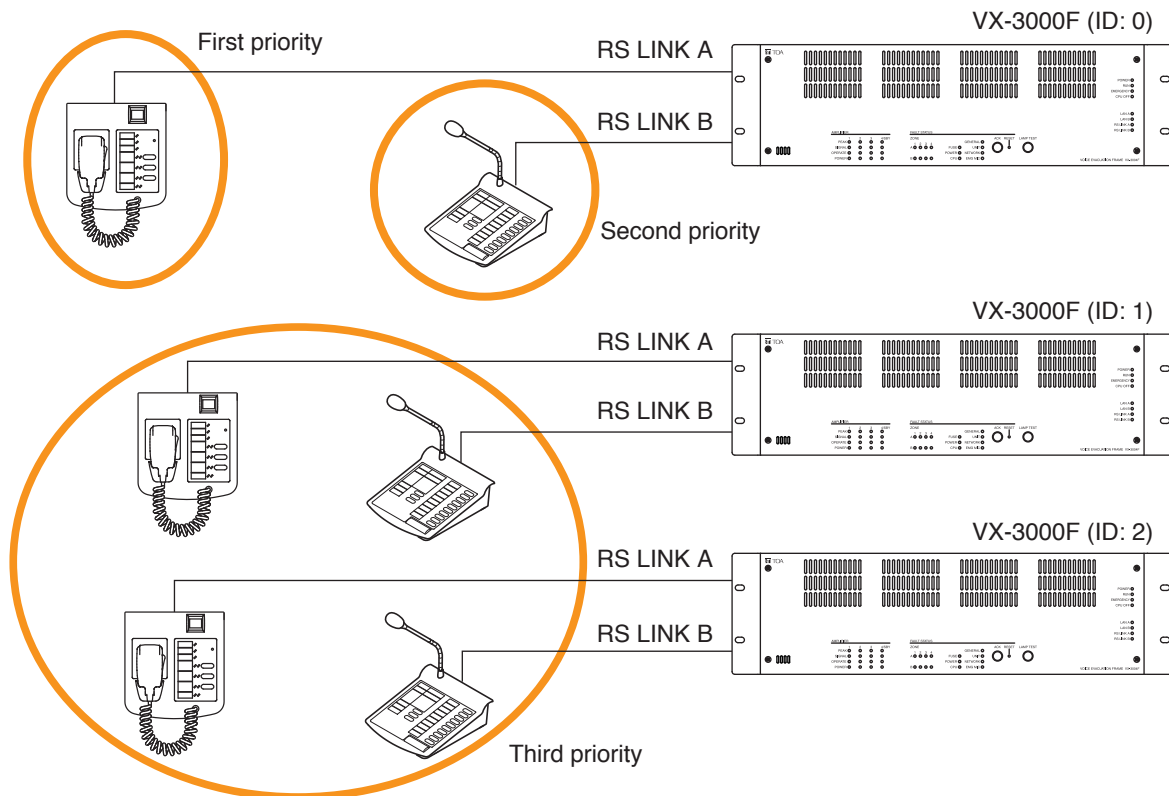

Following are operations when you activate a remote microphone to make broadcast.

- When broadcast from the remote microphone with higher priority is in progress, your broadcast cannot be made.
- When broadcast from the remote microphone with the same priority is in progress, your broadcast is mixed with the current broadcast in progress.
- When broadcast from the remote microphone with lower priority is in progress, your broadcast overrides the current broadcast in progress. When the overridden broadcast still continues after your broadcast is complete, it will resume.

#### Note

Never make All-zone emergency broadcast simultaneously using 2 or more Remote microphones connected to the same RS LINK connector.

Doing so may reduce broadcast sound volume and broadcast will not be made normally.



## 4.2. Making All-zone Emergency Broadcast from the RM-300X

Open the cover of the All-zone Emergency Broadcast key, then while holding down the key, wait about 4 seconds until the Failure indicator lights red and begin to make microphone announcements.

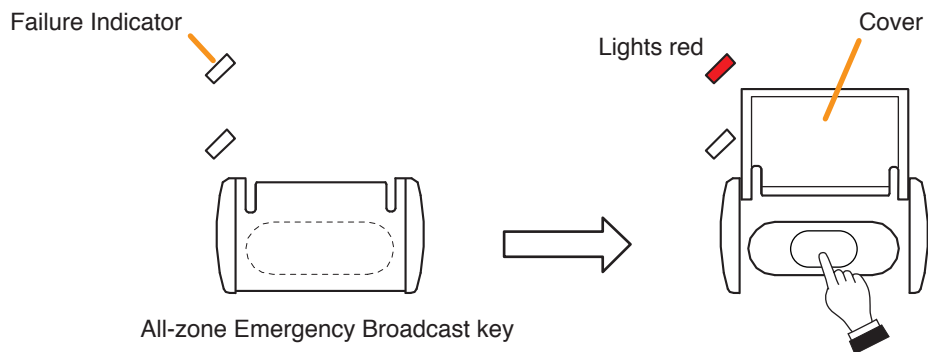

### Notes

- The RM-300X's DIP switch 5 (factory default: ON) must be preset to ON to enable the CPU OFF function (all-zone emergency broadcast).
- The event being activated from the remote microphone will be cleared when the system is placed in the CPU OFF state, and not restarted when its state is released.

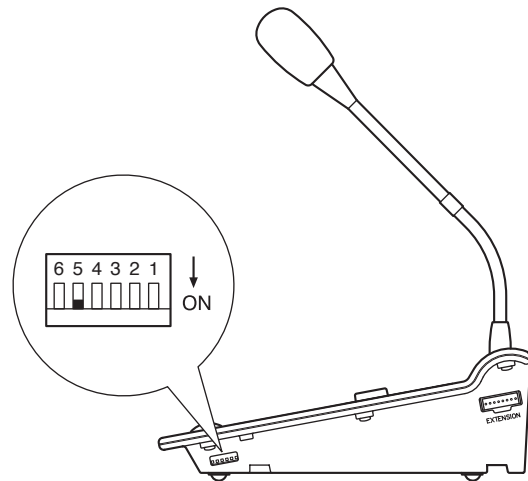

### 4.3. Making All-zone Emergency Broadcast from the RM-200SF

**Step 1.** Set the CPU switch on the top surface to OFF.

**Tip:** The CPU switch is factory-preset to ON.

RM-200SF front

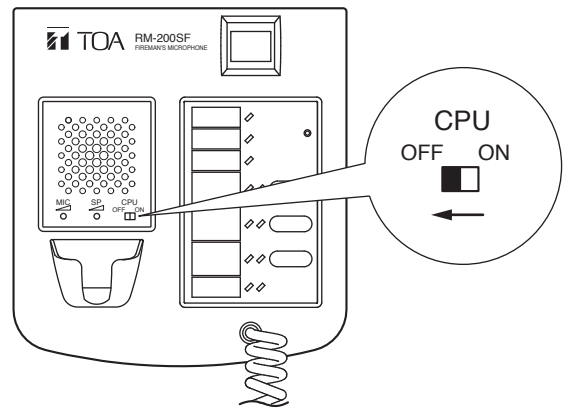

**Notes**

- The RM-200SF's DIP switch 6 (factory default: ON) must be preset to ON to enable the CPU OFF function (all-zone emergency broadcast).
- The event being activated from the remote microphone will be cleared when the system is placed in the CPU OFF state, and not restarted when its state is released.

RM-200SF rear

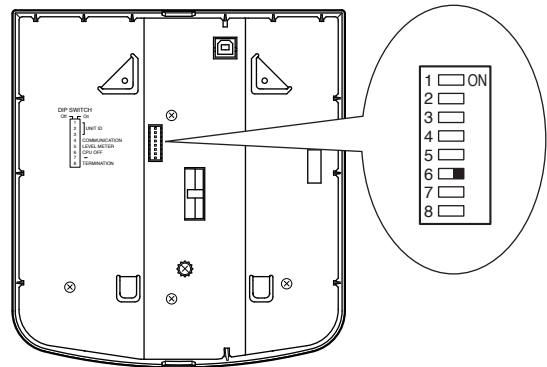

**Step 2.** Make the microphone announcement while holding down the Talk key.

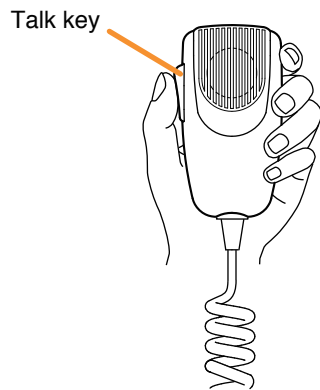

**Step 3.** When the microphone announcement is complete, return the CPU switch to ON.

## 5. DETECTING FAULT

If a malfunction occurs within the VX-3000 system, the fault state can be indicated, acknowledged or reset using the following keys or control terminals.

- FAULT ACK and FAULT RESET keys on the VX-3004F, VX-3008F, and VX-3016F
- Control input terminals of the VX-3004F, VX-3008F, and VX-3016F
- Function keys on the RM-300X or RM-200SF

### Note

Regarding the setting procedures for detecting fault within the VX-3000 system, see the separate Setting Software Instructions, "BASIC SETTINGS."

### 5.1. Fault Detection Setting Example

The method to detect the fault within the system using the VX-3004F, RM-200SF, and RM-320F is described below.

#### [System configuration]

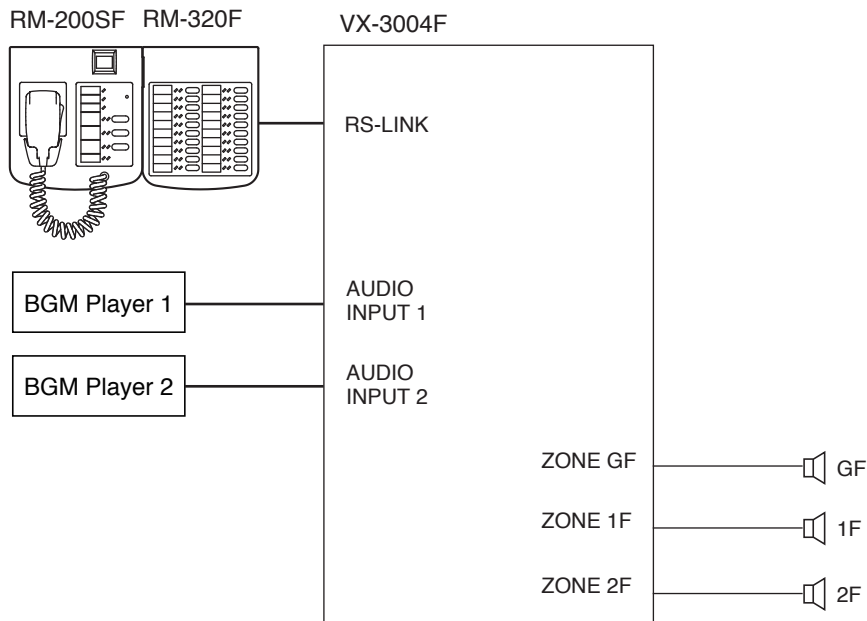

[Remote Microphone's Function key setting]

RM-200SF

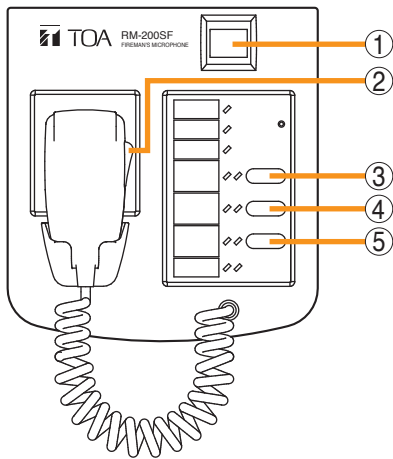

Key	Set function
(1)	(Not set)
(2)	Talk key (fixed)
(3)	Zone Clear
(4)	Failure Output Reset
(5)	Lamp Test

RM-320F

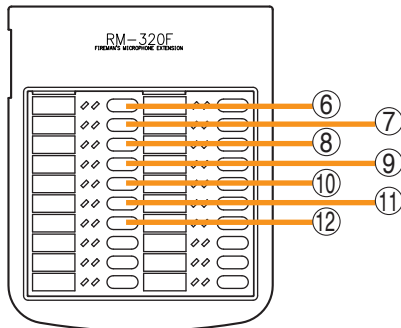

Key	Set function	Contents (failure pattern)
(6)	Failure Output Receipt	VX-3004F
(7)	Failure Output Receipt	Amplifier ZONE GF
(8)	Failure Output Receipt	Amplifier ZONE 1F
(9)	Failure Output Receipt	Amplifier ZONE 2F
(10)	Failure Output Receipt	Speaker ZONE GF
(11)	Failure Output Receipt	Speaker ZONE 1F
(12)	Failure Output Receipt	Speaker ZONE 2F

**Notes**

- For instructions on assigning functions to function keys, see the separate Setting Software Instructions, "EVENT SETTINGS."
- For instructions on setting failure pattern, see the separate Setting Software Instructions, "PATTERN SETTINGS."

**5.2. Case Example of Malfunction**

The example here assumes that the speaker terminal for the Zone 2F is disconnected.

VX-3004F

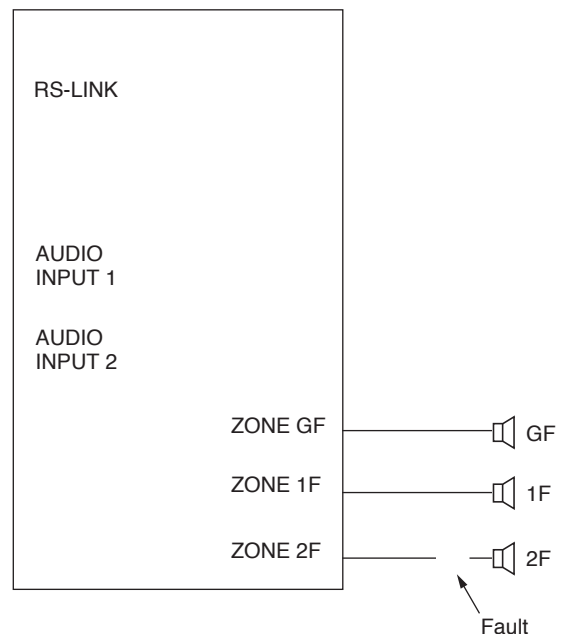

### 5.3. Remote Microphone's Operation Example

When the failure is detected, the buzzer built in the remote microphone sounds, and the Zone 2F failure output receipt state indicator flashes yellow.

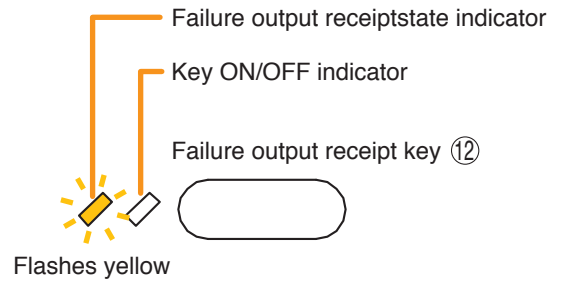

**Step 1.** Press the Failure output receipt key (12) to acknowledge the failure.  
The buzzer stops sounding, and the Failure output receipt state indicator switches from flashing to steady on.

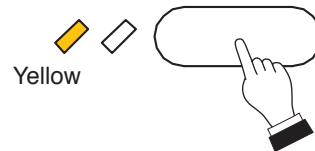

**Step 2.** Locate the cause, then remove it.  
Connect a PC to the VX-3004F and read out the log data using the VX-3000 Setting Software.  
For details, see the separate Setting Software Instructions, "MAINTENANCE."

Confirm the cause of failure or abnormality on the log data (in this example, the log data that the speaker terminal for the zone 2F is open state is listed), then fix the fault part.

**Note**

Operation of failure indication differs depending on which the Failure indication setting is set to "Auto reset" or "Manual reset" on the VX-3000 Setting Software.

[When set to "Auto reset"]

For most failure indications, the failure LED automatically goes off when the cause has been corrected. For certain other failure indications, such as power amplifier failure or speaker shorts, the LED does not automatically go off. In such cases, Failure Output Reset key needs to be pressed.

[When set to "Manual reset"]

The failure indication is retained until the Failure output reset key is pressed even when failure is restored.

**Step 3.** Press the Failure Output Reset key (4).  
The Failure output receipt state indicator goes off.

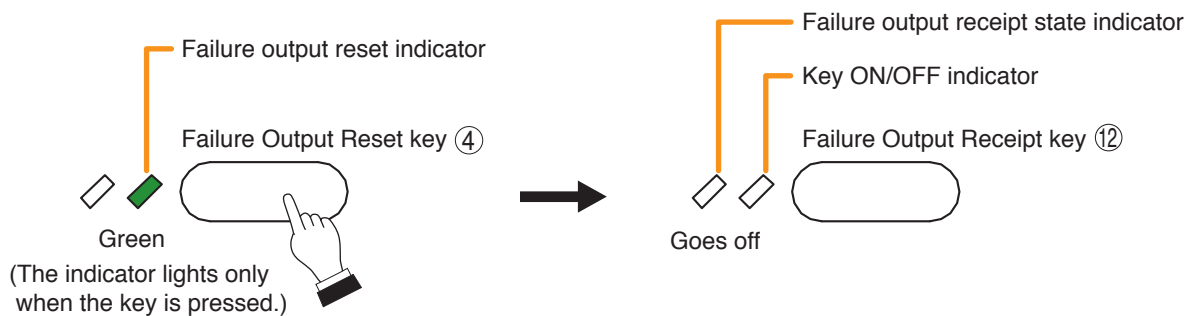

## 5.4. VX-3004F's Operation Example

When the failure is detected, the built-in buzzer sounds, and the General fault indicator on the front panel flashes.

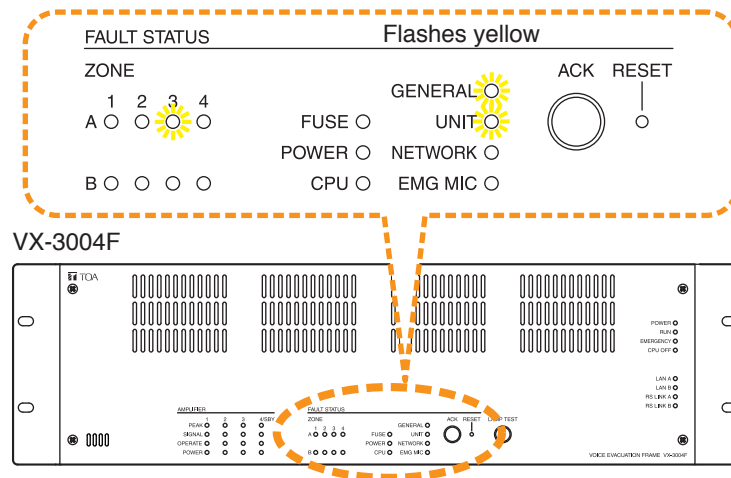

- Step 1.** Press the Fault ACK key to acknowledge the failure.  
The buzzer stops sounding, and the General fault indicator switches from flashing to steady on.

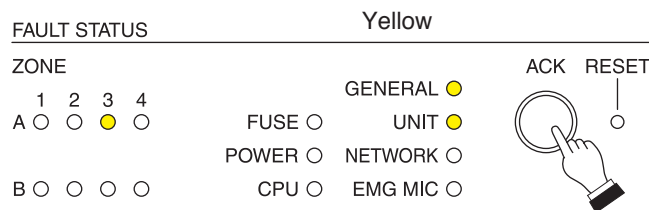

### Notes

- When the failure reception function has been assigned to the control input terminal on the rear panel of the VX-3004F, VX-3008F, or VX-3016F, it is also possible to receive a system failure via control input. For details, see the separate Setting Software Instructions, "EVENT SETTINGS."
- It is also possible to receive a system failure by shorting the Control input terminals on the rear panel of the VX-3004F, VX-3008F, or VX-3016F.

- Step 2.** Locate the cause, then remove it.  
Connect a PC to the VX-3004F and read out the log data using the VX-3000 Setting Software.  
For details, see the separate Setting Software Instructions, "Maintenance."

Confirm the cause of failure or abnormality on the log data (in this example, the log data that the speaker terminal for the zone 2F is open state is listed), then fix the fault part.

### Note

Operation of failure indication differs depending on which the Failure indication setting is set to "Auto reset" or "Manual reset" on the VX-3000 Setting Software.

[When set to "Auto reset"]

For most failure indications, the failure LED automatically goes off when the cause has been corrected.  
For certain other failure indications, such as power amplifier failure or speaker shorts, the LED does not automatically go off. In such cases, Fault reset key needs to be pressed.

[When set to "Manual reset"]

The failure indication is retained until the Failure reset key is pressed even when failure is restored.

**Step 3.** Reset the failure information.

There are 2 failure reset methods described below

**3-1.** Resetting the failure information using the Fault reset key

Press the Fault reset key.

The General fault indicator goes off, and the VX-3000 system returns to normal state.

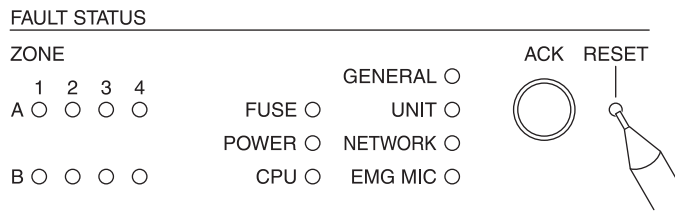

**Note**  
Use a fine-tipped object to press the Fault reset key.

**3-2.** Resetting the failure information by way of the Control input terminals

Reset the failure information using the terminal the failure reset function has been assigned to.

(For the function assignment, see the separate software instruction manual, "EVENT SETTINGS.")

Short the terminals with a one-shot pulse.

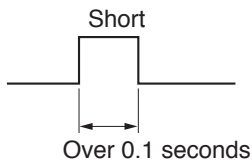

**5.5. Example of Executing the Failure Reception and Failure Reset by Way of the Control Input Terminals**

Assign the failure reception and failure reset functions to the control input terminals on the rear panel of the VX-3004F, VX-3008F, and VX-3016F in advance.

(For details, see the separate software instruction manual, "EVENT SETTINGS.")

Short each function-assigned terminals with a one-shot pulse.

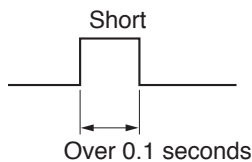

## 6. LAMP TEST

Executing the lamp test at each of the VX-3004F, VX-3008F, VX-3016F, RM-200SF, RM-300X, RM-320F, and RM-210F causes its all indicators to light up and the built-in buzzer to sound, permitting the operation test for the indicators and speaker.

### 6.1. Remote Microphone's Operation Example

#### [Remote Microphone's Function key setting]

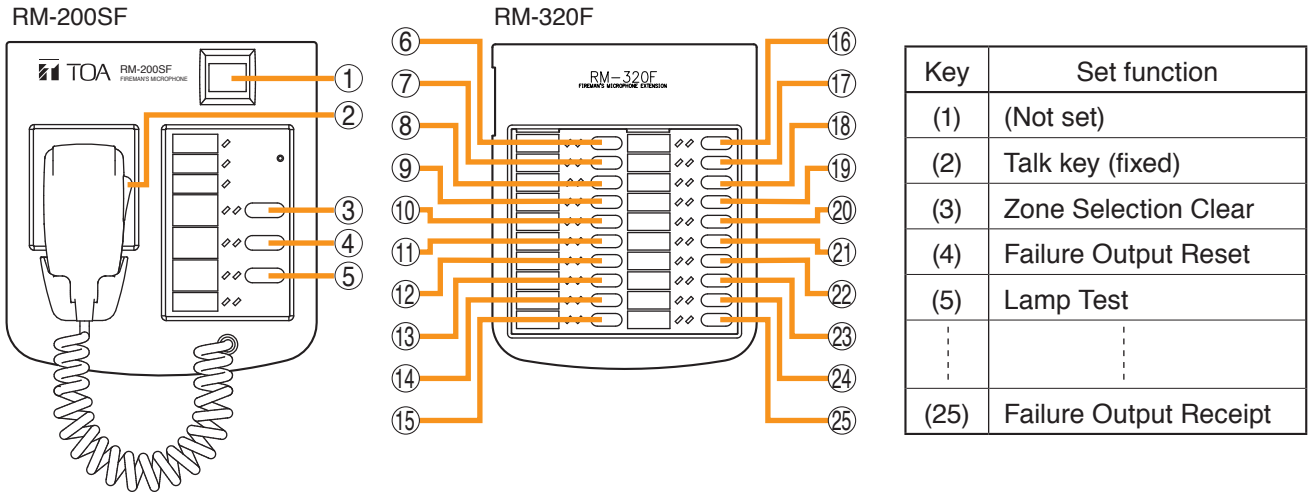

#### Note

For instructions on assigning functions to function keys, see the separate Setting Software Instructions, "EVENT SETTINGS."

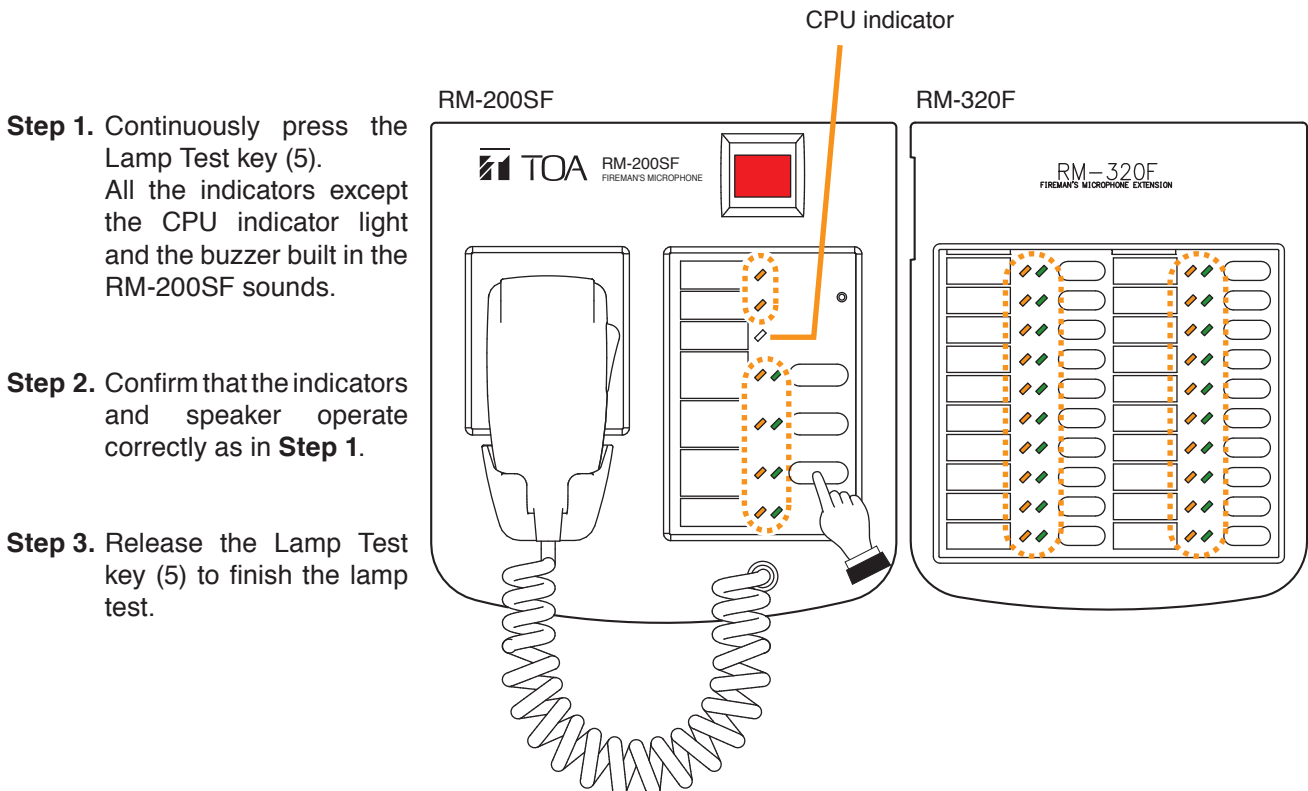



## 6.2. VX-3004F's Operation Example

- Step 1.** Continuously press the Lamp test key.  
All indicators light, and the buzzer built in the VX-3004F sounds.

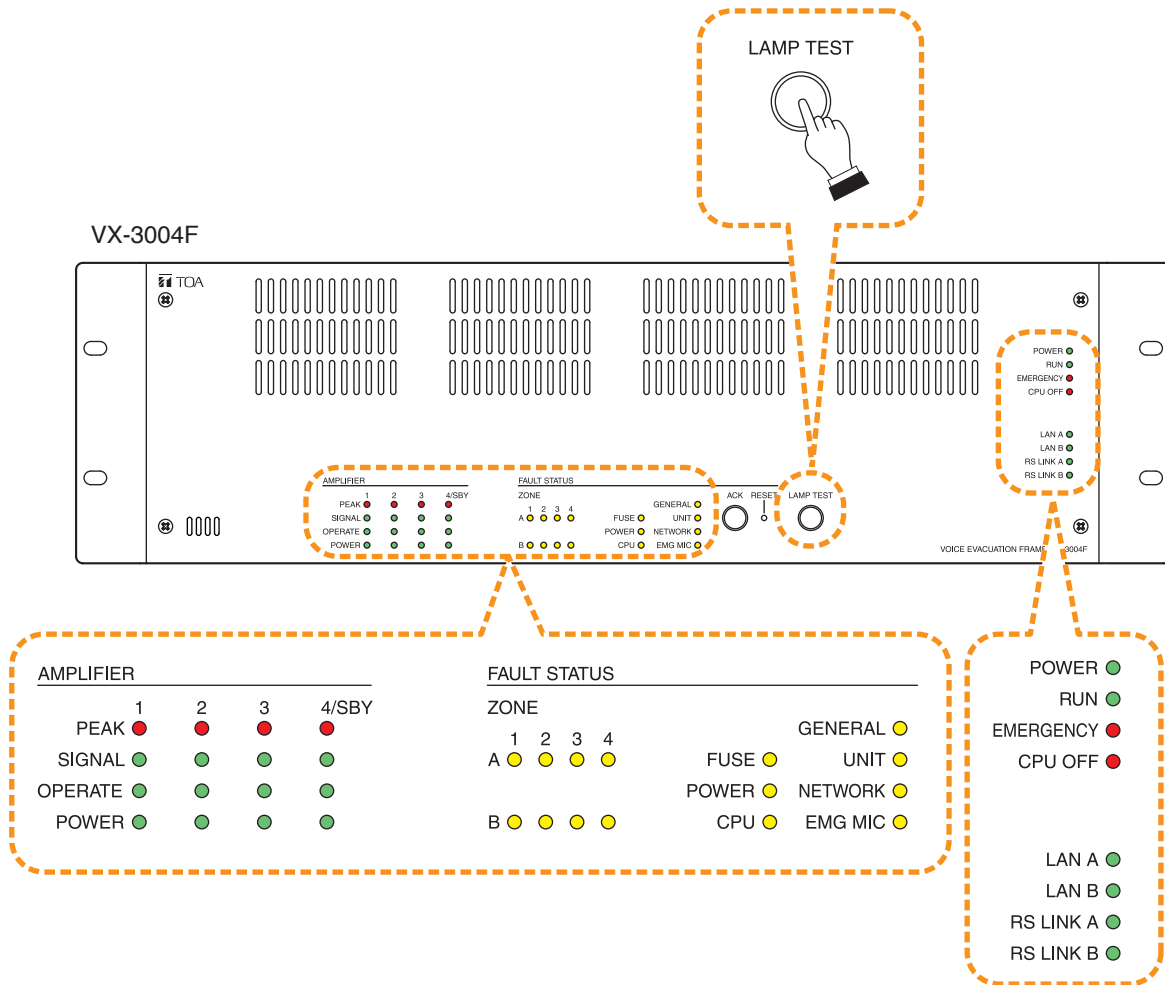

- Step 2.** Confirm that the indicators and buzzer operate correctly as in **Step 1**.

- Step 3.** Release the Lamp test key to finish the lamp test.

## 7. OTHER FUNCTIONS

Operations of audio monitor and control input/output can be performed using the Remote microphone's function key.

### [Setting example to function keys]

Key	Item Name	Function
Function key R7	Audio Monitor	Monitors audio signals being broadcast at an arbitrary zone.
Function key R8	Intended Control Input Operation	Makes the Intended control input Active.
Function key R9	Intended Control Output Operation (Pulse)	Activates the Intended control output pattern.
Function key R10	Intended Control Output Operation (Level)	Activates the intended control output pattern while this key is held down.

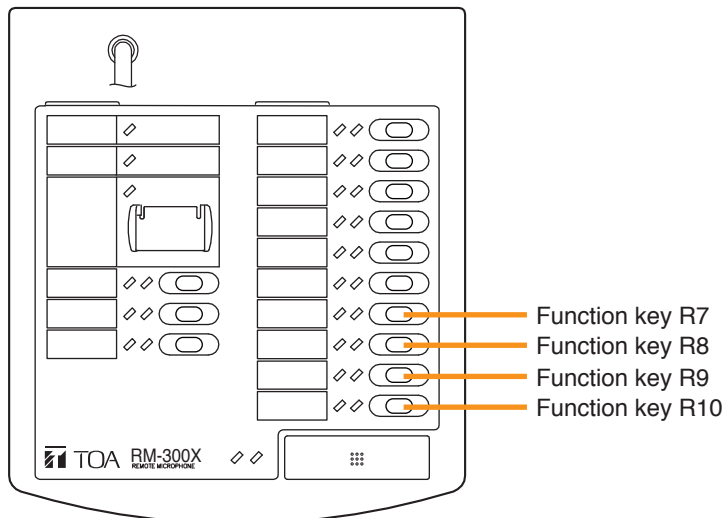

### 7.1. Audio Monitor

Audio signals during broadcast can be monitored by the remote microphone.

#### Step 1. Press the Audio monitor key.

The Broadcast status indicator lights green while audio signals are broadcast to the zone assigned to this function key.

Audio signals being broadcast in the zone assigned to the Audio monitor key are output from the remote microphone.

#### Notes

- No broadcast is output to the zone assigned to the Audio monitor key when the Broadcast status indicator is unlit.
- Only one remote microphone can be used for audio monitoring even when 2 or more remote microphones are connected to a single VX-3000F. Only the remote microphone of which Audio Monitor key is pressed most recently is effective for audio monitoring, causing other remote microphone engaged in monitoring to be interrupted.

#### Step 2. Press the Audio monitor key again to end monitoring. The Broadcast status indicator will go off.

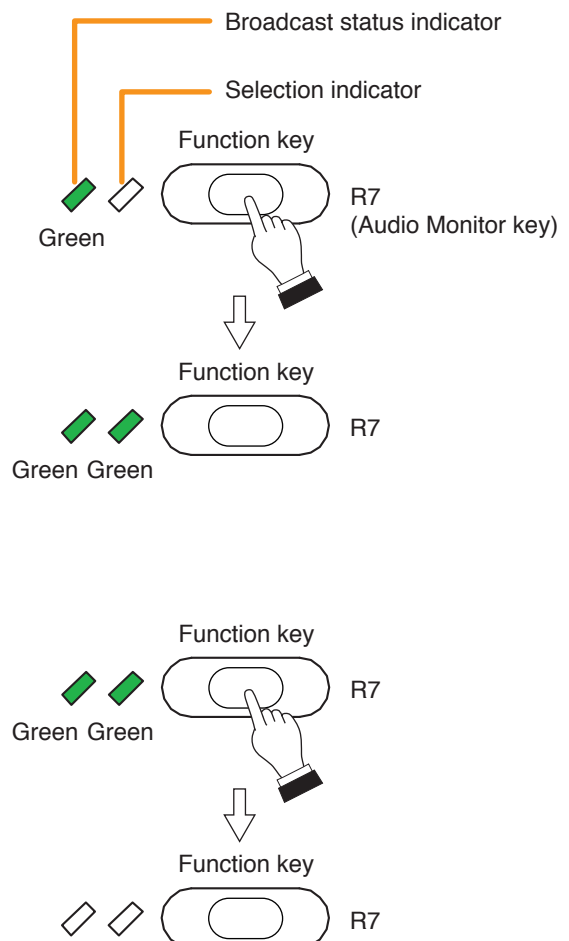

## 7.2. Intended Control Input Operation

The Intended control input of the VX-3000F can be operated using the Remote microphone's function key.

**Step 1.** Press the Intended control input key when the Control status indicator is unlit.

The control input assigned to the Intended control input key becomes active and the Control status indicator lights yellow.

**Note**

Operation is invalid even if you press the Intended control input key when the Control status indicator is lighting yellow though its key is not pressed. This is such a case when the control input is placed in Active state through other switch operation.

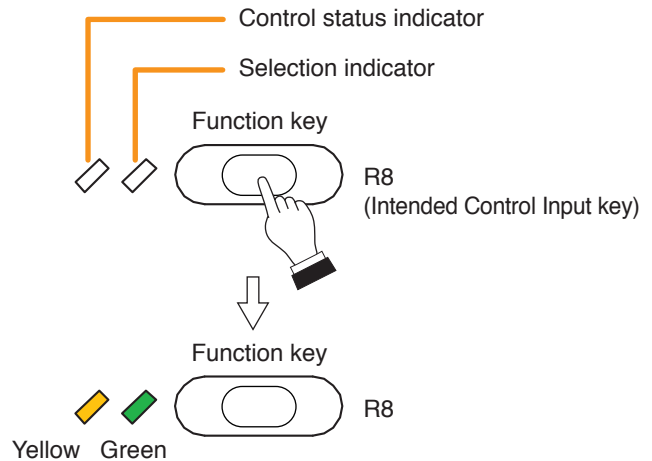

**Step 2.** Press the Intended control input key again to make the control input Inactive.

The Control status indicator will go off.

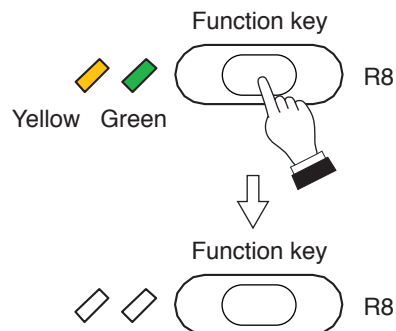

## 7.3. Intended Control Output Operation (Pulse)

The intended control output of the VX-3000F can be operated using the Remote microphone's function key.

**Step 1.** Press the Intended control output (pulse) key when the Control status indicator is unlit.

The Control output pattern assigned to the Intended control output (pulse) key is activated and the Control status indicator lights yellow.

**Note**

Operation is invalid even if you press the Intended control output (pulse) key when the Control status indicator is lighting yellow though its key is not pressed. This is such a case when the control output pattern is being activated by other Event.

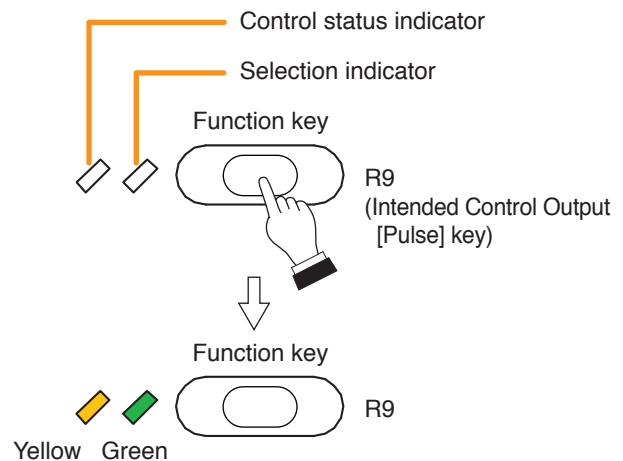

**Step 2.** Press the Intended control output (pulse) key again to end Control output pattern activation.

The Control status indicator will go off.

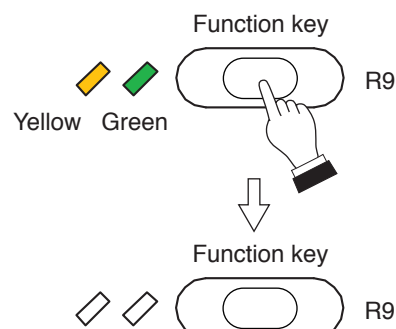

## 7.4. Intended Control Output Operation (Level)

The intended control output of the VX-3000F can be operated using the Remote microphone's function key.

**Step 1.** Hold down the Intended control output (level) key for the time you wish to activate the control output pattern while the Control status indicator is unlit.

The Control output pattern assigned to the Intended control output (level) key is activated and the Control status indicator lights yellow.

**Note**

Operation is invalid even if you press the Intended control output (level) key when the Control status indicator is lighting yellow though its key is not pressed. This is such a case when the control output pattern is being activated by other Event.

**Step 2.** To stop the control output pattern activation, release the Intended control output (level) key. The Control status indicator will go off.

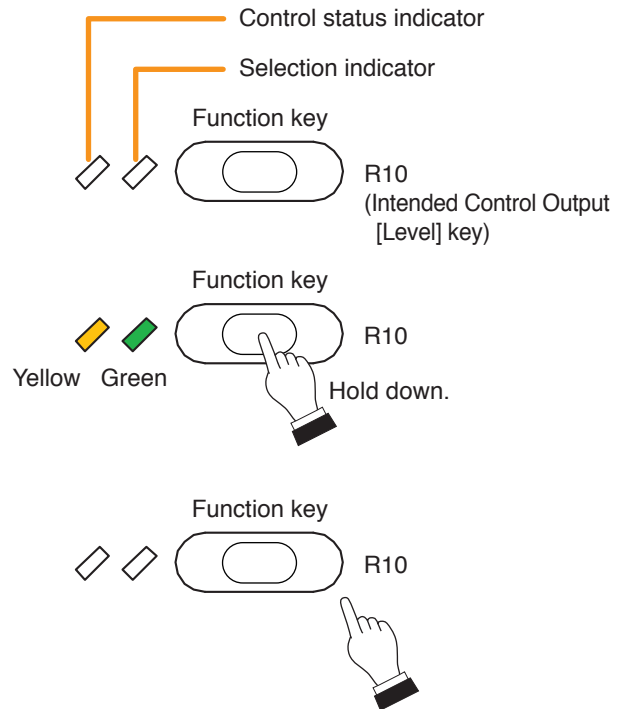

**Traceability Information for Europe**

Manufacturer:  
TOA Corporation  
7-2-1, Minatojima-Nakamachi, Chuo-ku, Kobe, Hyogo,  
Japan

Authorized representative:  
TOA Electronics Europe GmbH  
Suederstrasse 282, 20537 Hamburg,  
Germany

URL: <http://www.toa.jp/>