

The BS-1015BSW is certified according to the European Standard EN 54-24: 2008, the International Standard ISO 7240-24: 2010 and in compliance with the British Standard BS 5839-8: 2008 14.8. DoP number is 20-004.

## DESCRIPTION

The BS-1015BSW is the voice alarm certification product.  
 2 way speaker system is suitable for announcement and music use in wide frequency range.  
 Speaker design that harmonize with the venue's architecture and decor.

## SPECIFICATIONS

Rated Noise Power	15 W (100 V Line), 7.5 W (70 V Line)
Rated Impedance	100 V line: 670 Ω (15 W), 1 kΩ (10 W), and 2 kΩ (5 W) 70 V line: 670 Ω (7.5 W), 1 kΩ (5 W), 2 kΩ (2.5 W)
Sensitivity	90 dB (1 W, 1 m) (500 Hz - 5 kHz, pink noise) 87 dB (1 W, 1 m) (100 Hz - 10 kHz, pink noise) 75 dB (1 W, 4 m) (100 Hz - 10 kHz, pink noise)
Maximum Sound Pressure Level	98 dB (15 W, 1 m) (100 Hz - 10 kHz, pink noise) 86 dB (15 W, 4 m) (100 Hz - 10 kHz, pink noise)
Frequency Response	80 Hz - 20 kHz
Coverage Angle	Horizontal: 220° (500 Hz), 150° (1 kHz), 120° (2 kHz), 90° (4 kHz) Vertical: 330° (500 Hz), 160° (1 kHz), 120° (2 kHz), 70° (4 kHz)
Environmental Type	A (indoor applications)
Speaker Component	Low frequency: 12 cm (5") cone-type High frequency: 2.5 cm (1") balanced dome tweeter
Enclosure Type	2-way bass-reflex system
Operating Temperature	-10 °C to +50 °C (14 °F to 122 °F)
Speaker Mounting Method	Wall-mount
Cable Gland	Size: PG 13.5 One cable gland is factory-installed. For bridge connection, one supplied cable gland can be added.*
Applicable Cable	Outer diameter: Ø6.6 - Ø12.5 mm Conductor: Solid wire or 7-core wire No bridge connection: 0.8 - 10 mm <sup>2</sup> (AWG18-AWG7) for solid wire, 0.8 - 8 mm <sup>2</sup> (AWG18-AWG8) for 7-core wire Bridge connection: 0.8 - 2.5 mm <sup>2</sup> (AWG18-AWG13) for solid wire, 0.8 - 1.5 mm <sup>2</sup> (AWG18-AWG15) for 7-core wire
Connection	Screw connector (steatite terminal) can be bridge connection
Finish	Enclosure: ABS resin, white (RAL9010 or equivalent color), paint Grille: Surface treated steel plate net, white (RAL9010 or equivalent color), powder coating Bracket: Surface treated steel plate, white (RAL9010 or equivalent color), powder coating
Dimension	196 (W) x 290 (H) x 186 (D) mm (7.72" x 11.42" x 7.32") (without bracket)
Weight	2.4 kg (5.29 lb) (without bracket)
Accessory	Bracket-1, Bracket mounting screw-2, Rear cover-1

\*Suppliable cable gland's partcord and partname "525-52-011-70: Cable gland AVC PGB13.5-12 (GRY)"

[Note] Install with the front facing downward. Note that the splash-proof capability will be lost if installed face-up.  
 The logo mark needs to be located in the lower section when the speaker is installed vertically, and on the right side of the speaker (as viewed from the front) when installed horizontally.

■ APPEARANCE

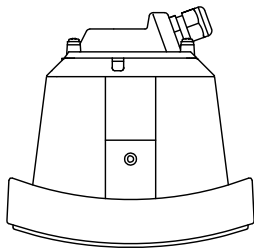

Top View

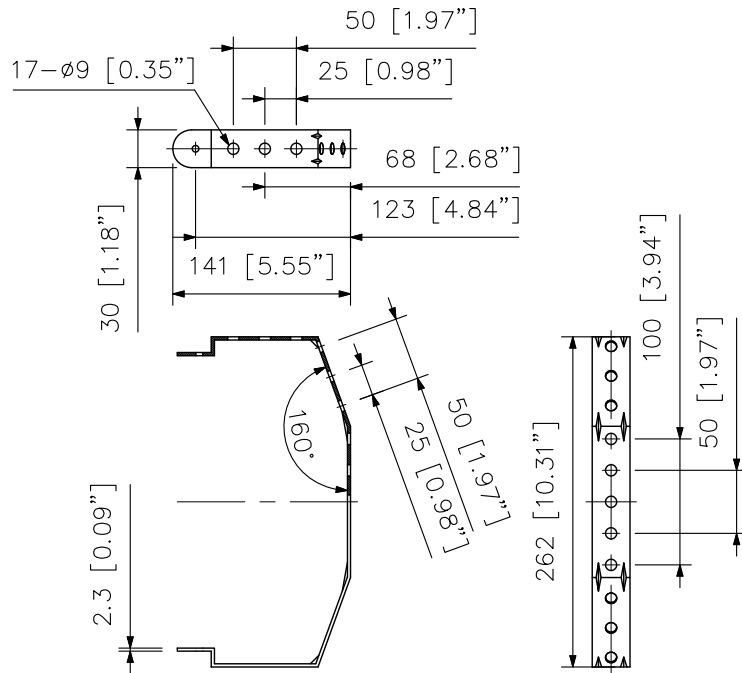

Bracket (accessory)

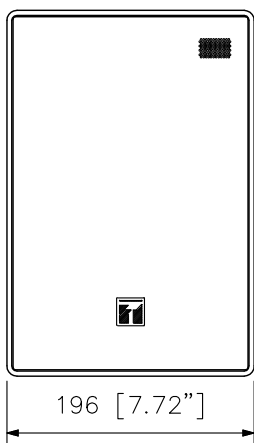

Front View

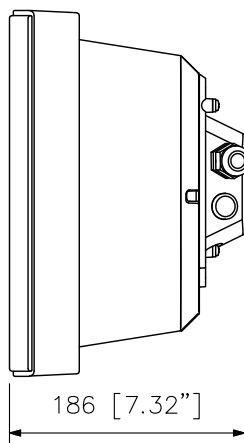

Side View

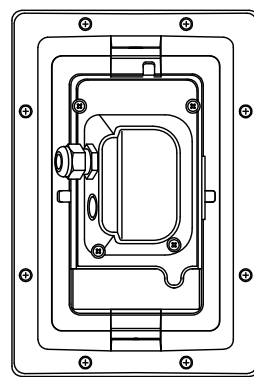

Rear View

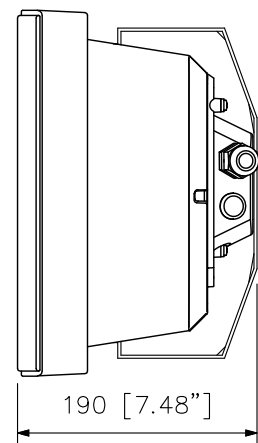

Bracket installation figure

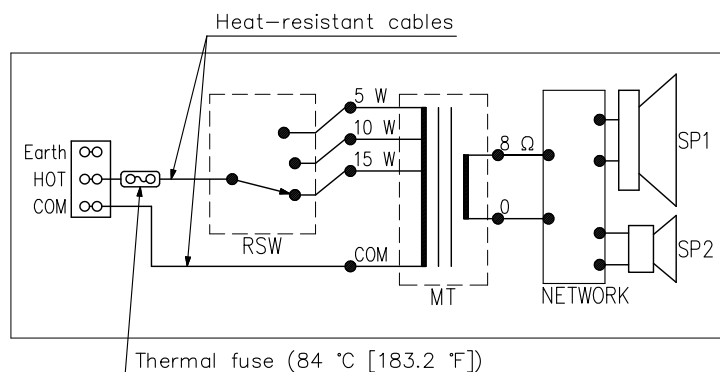

Wiring diagram

UNIT:mm SCALE:1/6